



# QUIRK BOOKS

2023 Bologna  
Rights Guide

# ABOUT QUIRK BOOKS



Quirk Books is a Philadelphia publisher with 20 years of history offering:

Hundreds of Books \* 10+ *New York Times* Best Sellers \* Multiple Book-To-Movie Adaptations \* Millions of Fans and Readers \* Books in Over 40 Languages Worldwide on all Continents \*

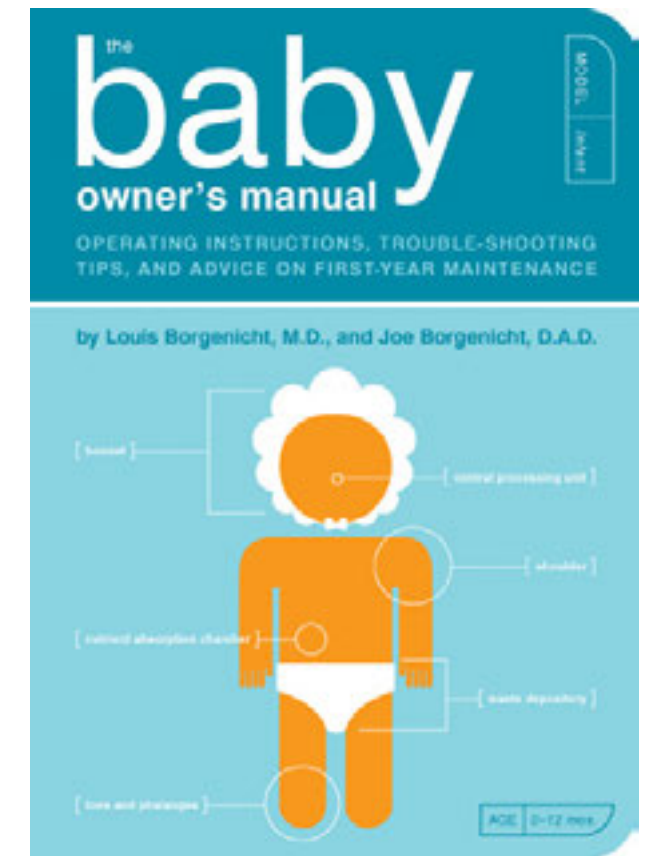
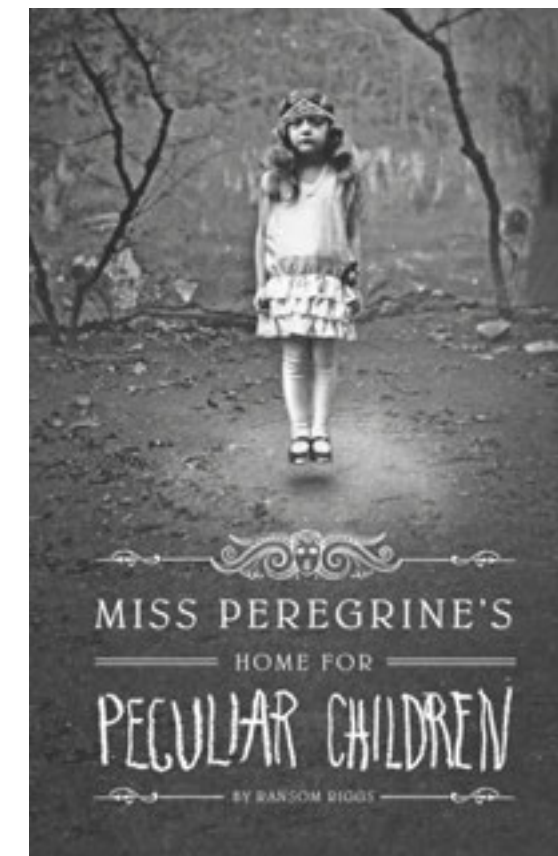
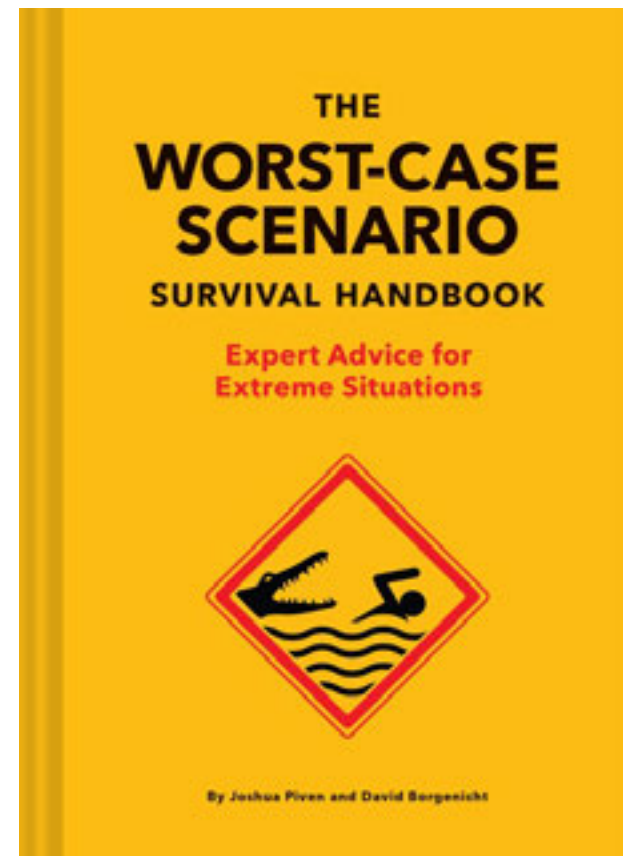
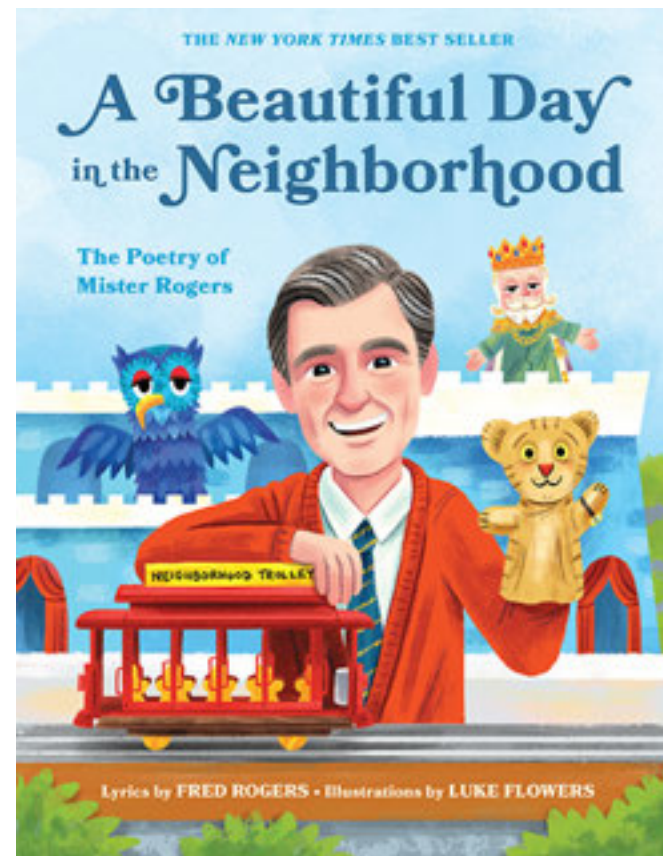
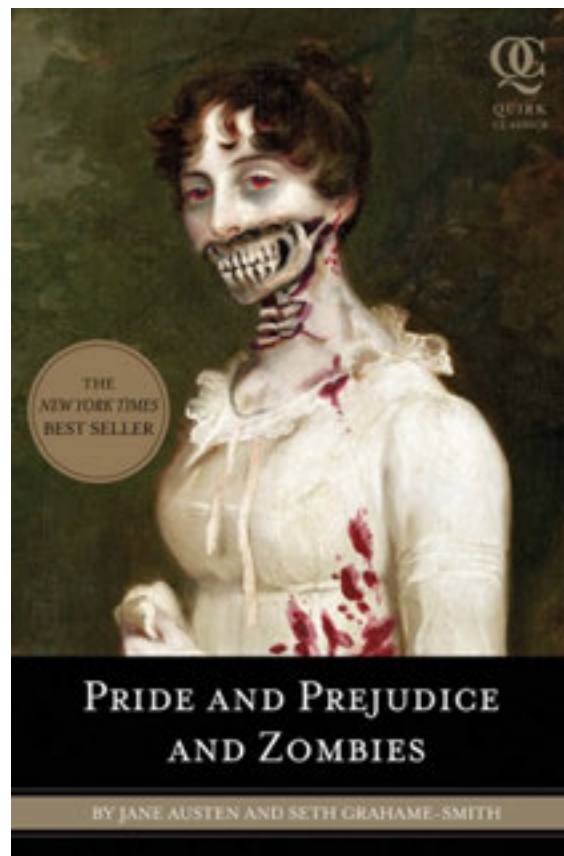

Founded in 2002, Quirk Books publishes a highly curated list of entertaining, enlightening, and strikingly unconventional books for adults and children in a number of genres and categories. Quirk publishes books that are meant to be shared and discussed—books that are objects of desire—and that have the potential to reach the widest possible readership because of their positioning and packaging.

Quirk Global Publishing Partners and Licensees Include:

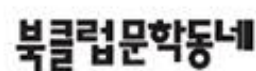

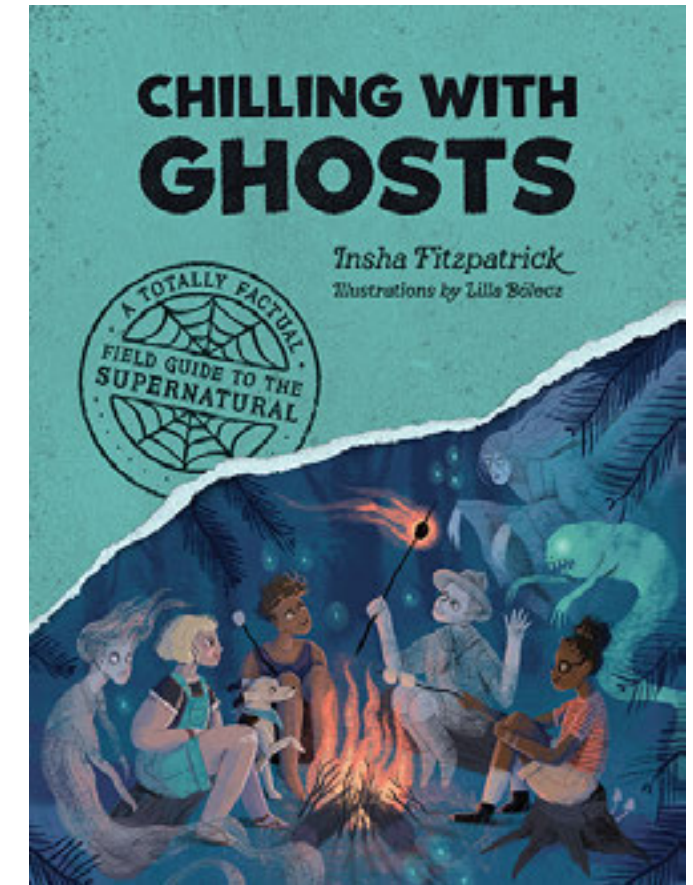
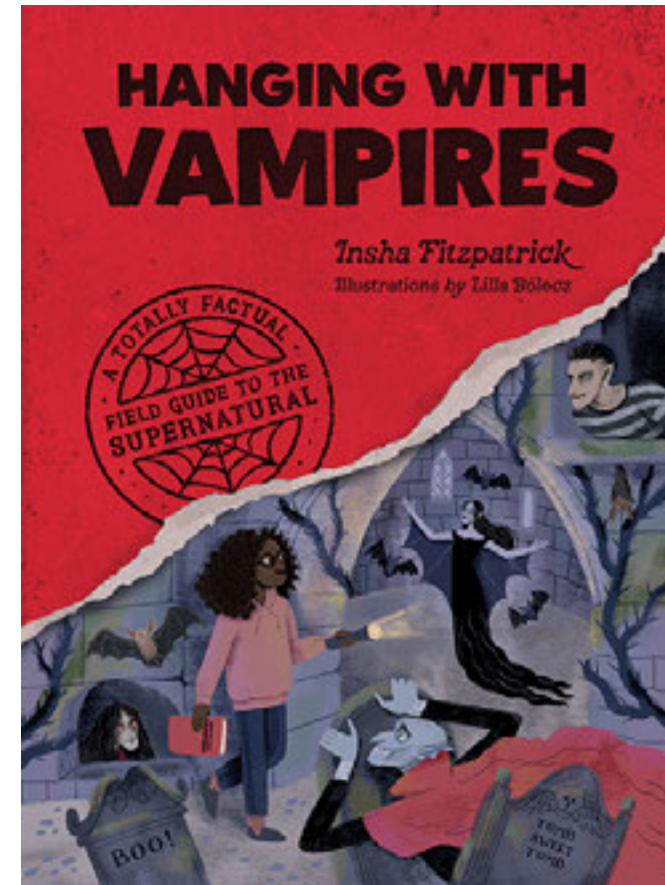

**STARS, HIDE YOUR FIRES**  
by Jessica Best  
Age 14+

A wanted thief. A murdered emperor. A killer loose on the station. *Knives Out* goes sci-fi in this gripping YA mystery set in space.

**A SPOONFUL OF TIME**  
by Flora Ahn  
Ages 8-12

A heartwarming, unforgettable middle grade novel where time travel, family recipes, and family secrets collide.

**HANGING WITH VAMPIRES**  
by Insha Fitzpatrick  
Ages 8-12

Discover everything about vampires in this nonfiction handbook packed with spooky legends, fascinating history, and weird facts!

**CHILLING WITH GHOSTS**  
by Insha Fitzpatrick  
Ages 8-12

Learn all about ghosts in this fun handbook packed with spooky tales, engrossing science, and fascinating history, perfect for middle grade mythology fans!



**KID OLYMPIANS:  
SUMMER**  
by Robin  
Stevenson  
Ages 8-12

Inspiring, relatable, and totally true biographies tell the childhood stories of a diverse group of international athletes.

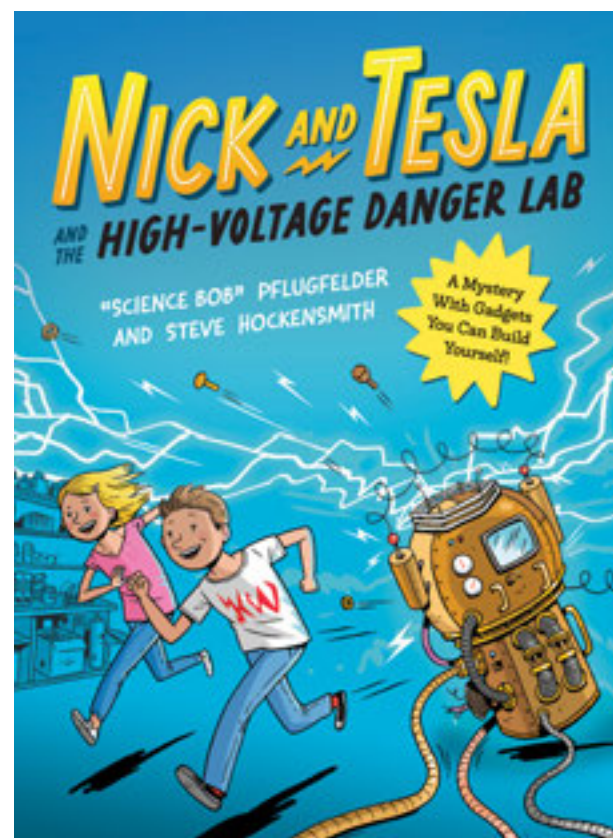

**NICK AND TESLA  
VOLUME #1**  
by B. Pflugfelder  
& S. Hockensmith  
Ages 8-12

Solve mysteries using DIY science projects with twin sleuths Nick and Tesla in this zany, action-packed middle grade adventure!

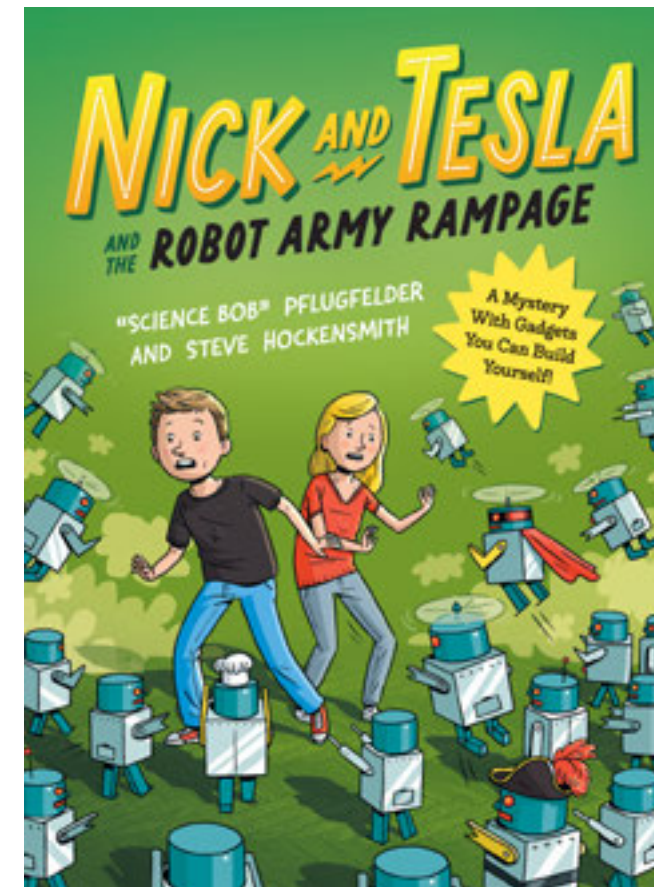

**NICK AND TESLA  
VOLUME #2**  
by B. Pflugfelder &  
S. Hockensmith  
Ages 8-12

Join twins Nick and Tesla as they build homemade robots and race to solve a mystery in this wacky and thrilling middle grade adventure sequel!



**LET'S FIND YAYA  
AND BOO AT  
HOME!**  
by Andrew Knapp  
Ages 0-5

Play hide-and-peek with adorable dogs Yaya and Boo in this joyful board book from the creator of the Find Momo series!



## Contents:

- Click to go to the section of your choosing:
  - [Kids, MG, and YA](#)
    - [Board Books](#)
    - [MG Fiction](#)
    - [MG Nonfiction](#)
    - [YA Fiction](#)
- To request more information and register interest: [rights@quirkbooks.com](mailto:rights@quirkbooks.com)

# **BOARD BOOKS**

For age 0-5



## About the FIND MOMO series

Momo, Yaya, and Boo are dogs who love to play hide-and-seek with you! Look for these adorable pup pals hiding in the stunning photography of their best friend, Andrew Knapp. Adult & kids titles are available.

55,000  
copies  
sold

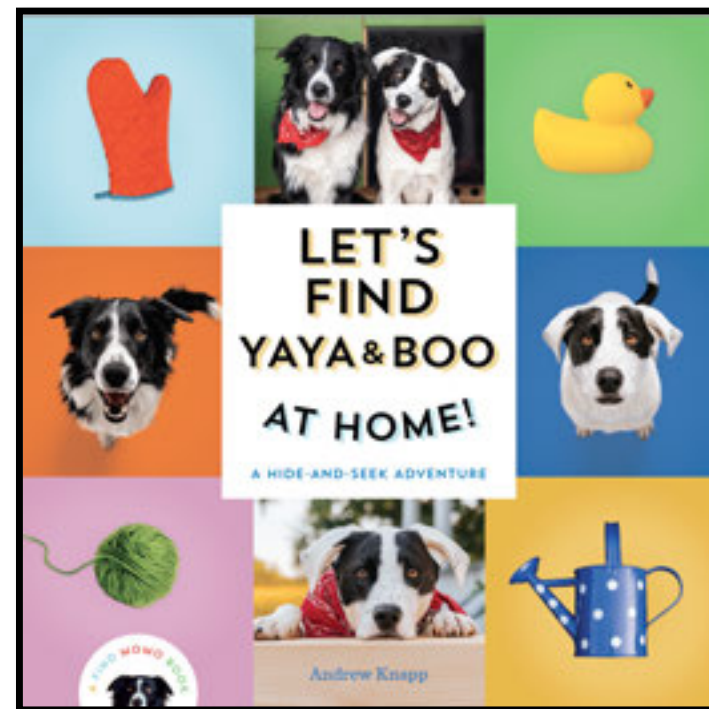

80,000  
copies  
sold

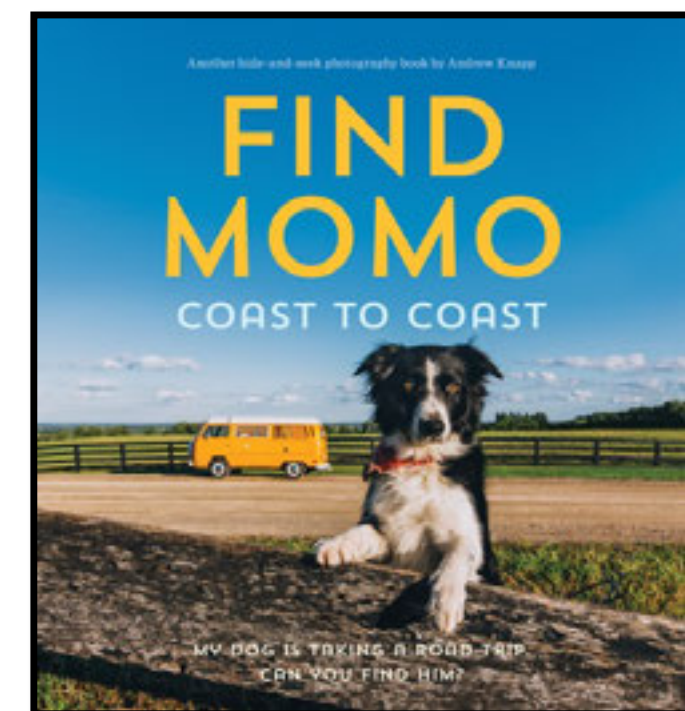
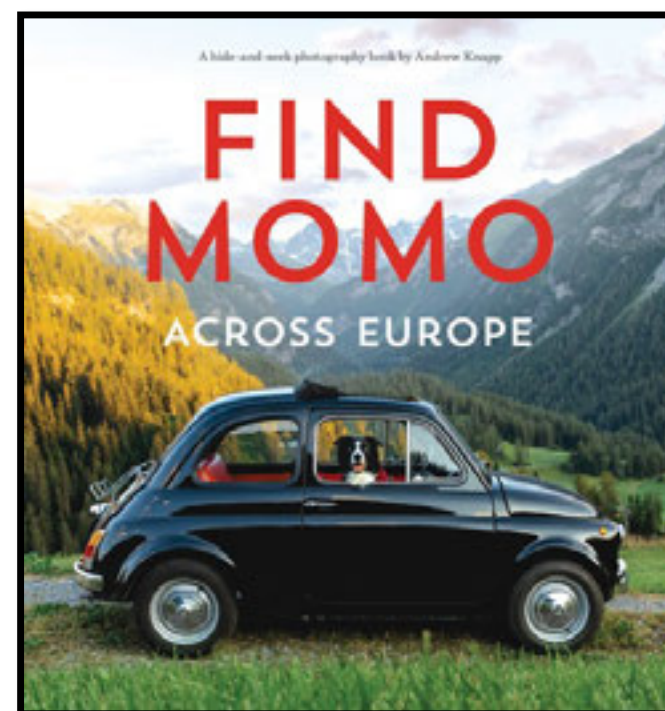
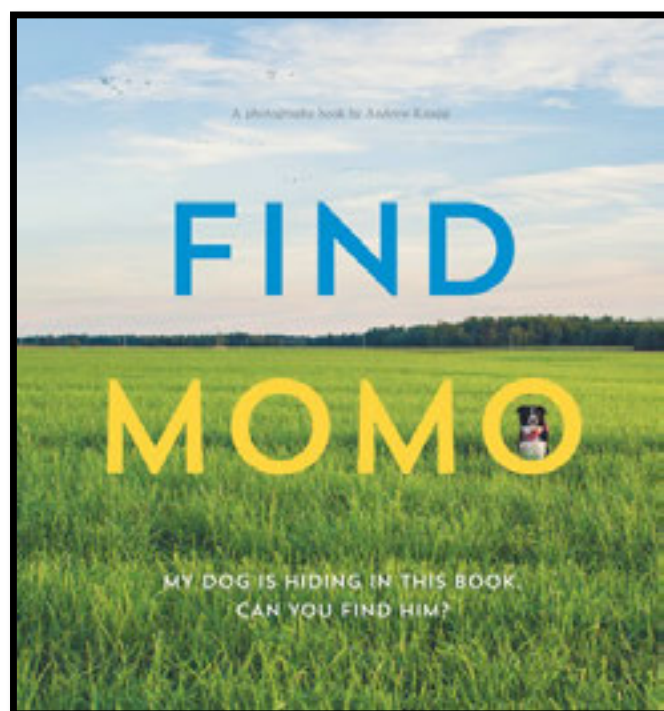

# LET'S FIND YAYA AND BOO!

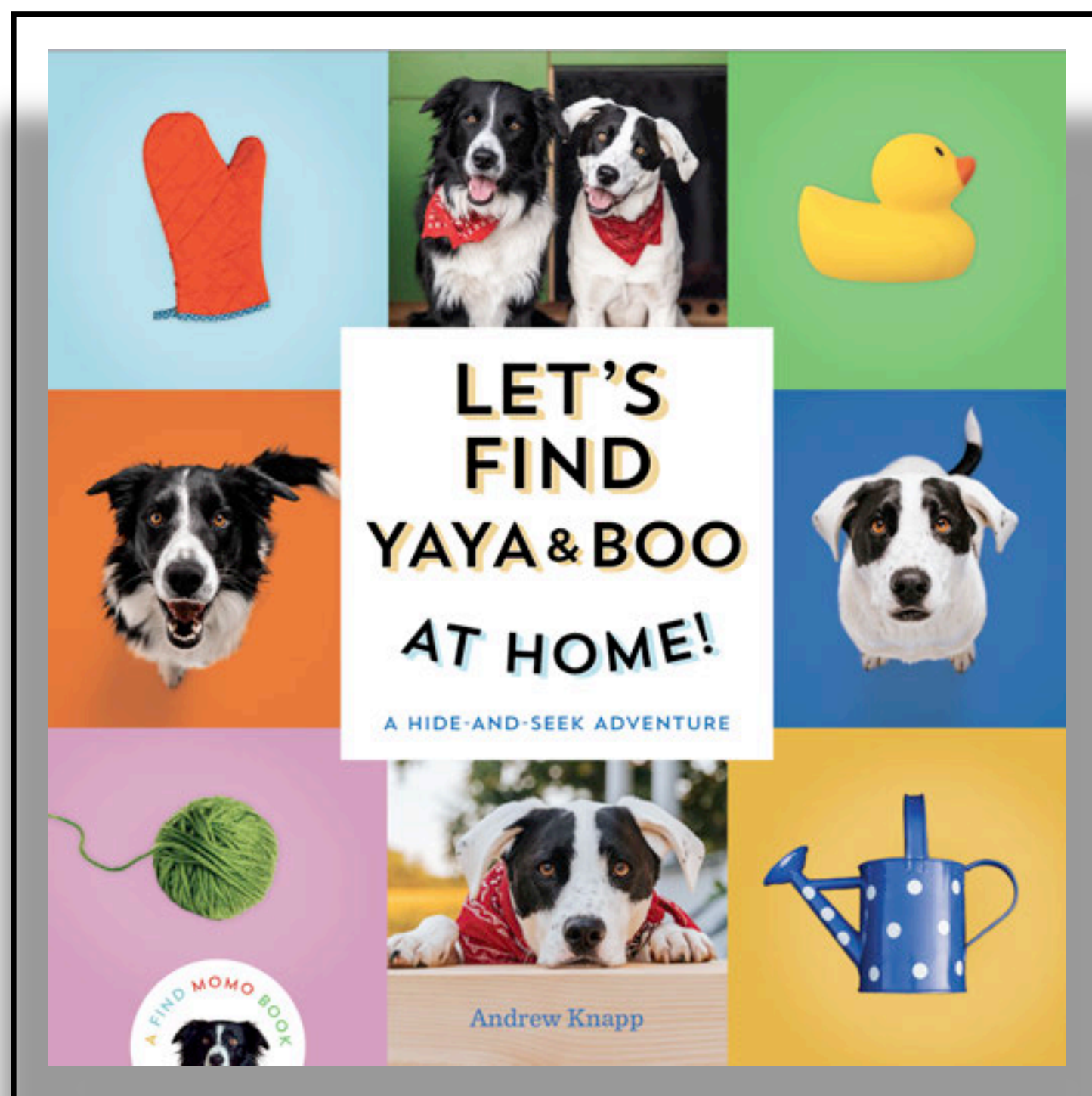

Play hide-and-seek with adorable dogs Yaya and Boo in this joyful book from the creator of the Find Momo series!

## TARGET CONSUMER:

- Children ages 0-5
- Dog lovers
- Parents and gift givers
- Fans of Andrew Knapp and Find Momo





# LET'S FIND YAYA AND BOO AT HOME!



Can you find the objects hidden in the picture? Or the two dogs hiding in the picture?

(No photoshopping was involved—the dogs know how to hide for photos!)



## Quirk Books, May 2021

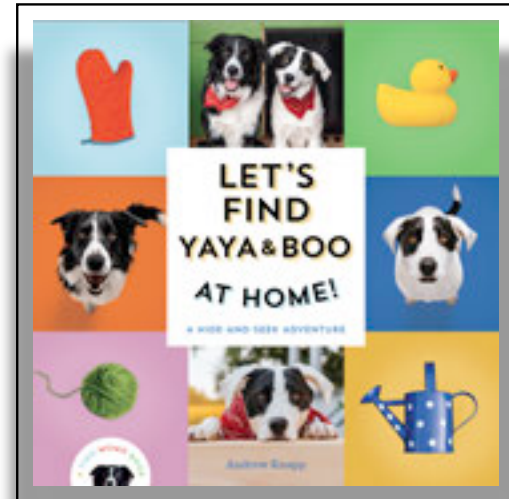

- AGE RANGE: 0 to 5
- SPECS: 24 pages, 8" x 8", 4 color
- SERIES : Find Momo
- RIGHTS SOLD: All rights available
- SUBJECT AREAS:
  - Juvenile Nonfiction – Animals - Dogs
  - Games & Activities
  - Photography

### About the book:

Play hide-and-seek with adorable dogs Yaya and Boo in this joyful book from the creator of the Find Momo series!

Where is Yaya, and what mischief is Boo getting into? Look for canine buddies Yaya and Boo at a lemonade stand by the end of the driveway, hidden in the flower beds near the front porch, waiting for a snack at the kitchen table, and more! Learn new words by searching for objects in each picture, and spot Yaya and Boo in the unlikeliest places.

Whether they're hiding in a cardboard castle or snuggling in a pile of stuffed animals, Yaya and Boo show us that staying at home can be an adventure, too!

# LET'S FIND MOMO OUTDOORS!



Explore the great outdoors with Momo the adorable border collie and his new puppy companion Boo in this bright, friendly board book! Babies, toddlers, and parents will love playing hide-and-seek with Momo.

## TARGET CONSUMER:

- Children ages 0-5
- Dog lovers
- Parents and gift givers
- Fans of Andrew Knapp and Find Momo



# LET'S FIND MOMO OUTDOORS!



LET'S FIND...



MOMO



BOO



BOOTS



BINOCULARS



COMPASS





## Quirk Books, May 2021



- AGE RANGE: 0 to 5
- SPECS: 24 pages, 8" x 8", 4 color
- SERIES : Find Momo
- RIGHTS SOLD: French (Grandes Personnes)
- SUBJECT AREAS:
  - BISAC 1: Juvenile Nonfiction – Animals - Dogs
  - BISAC 2: Juvenile Nonfiction – Games & Actuates
  - BISAC 3: Juvenile Nonfiction - Sports & Recreation - Camping & Outdoor Activities

### About the book:

Explore the great outdoors with Momo the adorable border collie dog and his new puppy companion Boo in this bright, friendly board book! Babies, toddlers, and parents will love playing hide-and-seek with Momo.

Beloved dog Momo is back...if you can find him! In this follow-up to *Let's Find Momo!*, spend a day with Momo as he sets off on a nature adventure. From the mountains to the beach to camping under the stars, young readers will delight in finding Momo in unexpected and beautiful locations. Plus, Momo has an adorable new puppy friend: Boo!

In this sturdy board book kids can keep the game going—and learn new words—by searching for objects in each picture. With stunning photographs, bright colors, and Momo's friendly face on every page, *Let's Find Momo Outdoors!* delivers exactly what fans loved in the previous Momo books—with plenty of new sights to see and objects to find.

# CAT'S FIRST BABY

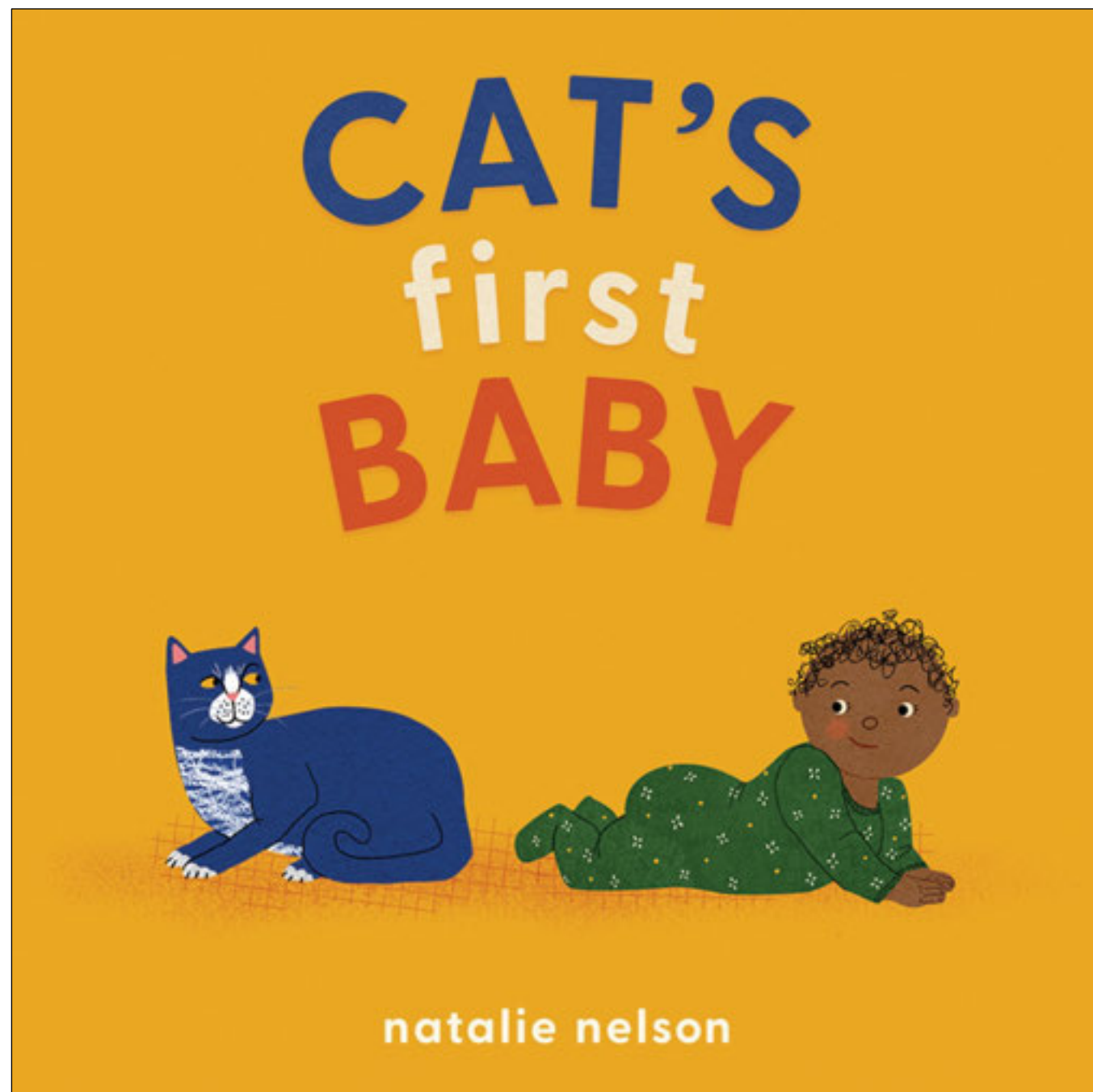

I am a cat.

Are you a cat?

## TARGET CONSUMER:

- Young children (age 2-5) who love cats
- Cat loving parents preparing kids for a new sibling
- People shopping for baby shower and new baby gifts

Rights Sold: Italian (Il Castoro)





## Quirk Books, March 2022

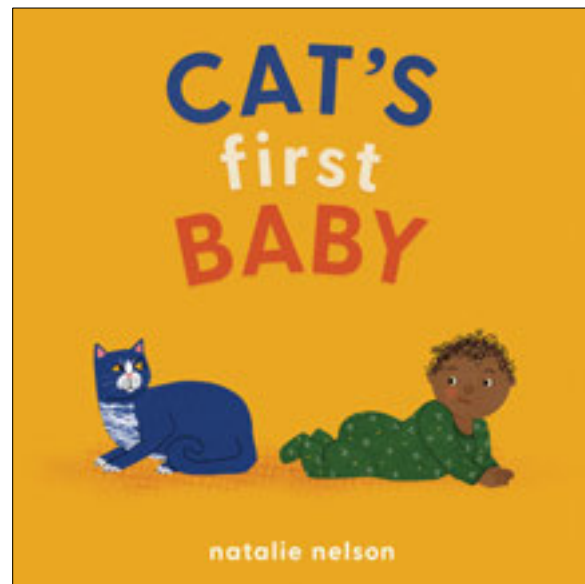

AGE RANGE: 2 to 5

SPECS: 28 pages, 7" x7" - 4 color board book

SUBJECT AREAS:

BISAC 1: Juvenile Nonfiction – Family – New Baby

BISAC 2: Juvenile Nonfiction – Animals - Cats

BISAC 3: Juvenile Nonfiction – Animals - Pets

Over  
15,000  
copies sold  
In 1 year

## ABOUT THE BOOK

### I am a cat. Are you a cat?

Cat is curious. There's a new addition to the family, but what exactly *is* this small creature? It doesn't meow like a cat, or smell like a cat, or even have a tail like a cat. As Cat satisfies his curiosity, he may come to appreciate this loud, silly creature. After all, this new arrival enjoys a good catnap, too.

In *Cat's First Baby*, the feline companion to *Dog's First Baby*, Natalie Nelson captures the wonder and humor of a new family member through a cat's eyes. Sure to delight kids and cat parents alike, this board book promises to be a repeat read-aloud.

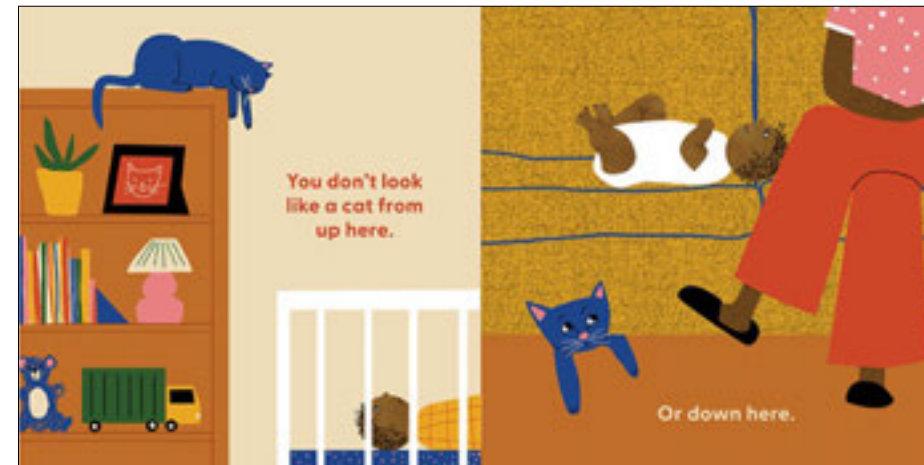

## KEY SELLING POINTS:

- **A PLAYFUL TWIST ON AN EVERGREEN CONCEPT:** Picture books about bringing home a new baby are classic for good reason—it's an exciting time for the family! Human siblings will relate to the cat's curiosity. The sparse text offers a gentle lesson about accepting a new family member, while highlighting the silliness and entertainment along the way.
- **"CAT PARENTS" TO HUMAN PARENTS:** Approximately 35% of American households have cats, and plenty of those will eventually welcome a baby, too. This is a natural purchase for those transitioning!
- **ENDLESS GIFT POTENTIAL:** With a sturdy board book format, this will be an easy addition to baby shower and new baby gifts for cat-loving parents and feline fans.
- **AUTHOR/ILLUSTRATOR WITH EYE-CATCHING STYLE:** Natalie Nelson has illustrated several critically-acclaimed picture books. She works in a colorful mixed media hybrid of collage, cut paper, and digital magic that is striking and sophisticated, sure to appeal to millennial parents.
- **CANINE COMPANION:** Dog lovers, we've got you covered—check out *Dog's First Baby!*



# DOG'S FIRST BABY



A playful and heartwarming board book from the perspective of a skeptical dog who must come to terms with--and maybe even become friends with--a peculiar new family member. Perfect for dog loving families and new parents!

## TARGET CONSUMER:

- Children ages 2-5 who love dogs
- Dog loving parents preparing kids for a new baby
- People shopping for "new baby" gifts

## Rights Sold:

- Italian to Il Castoro
- French to Le Père Castor

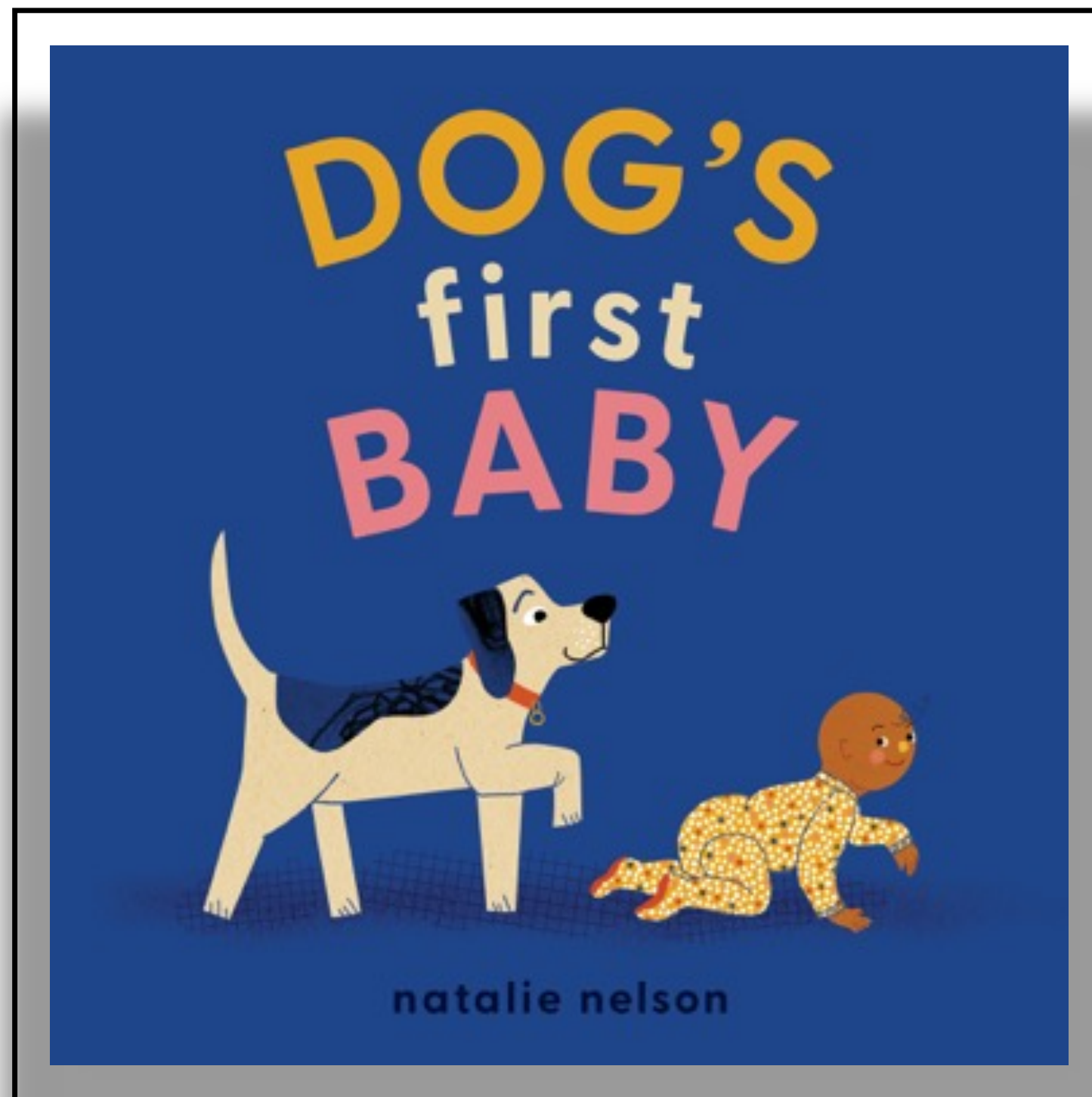

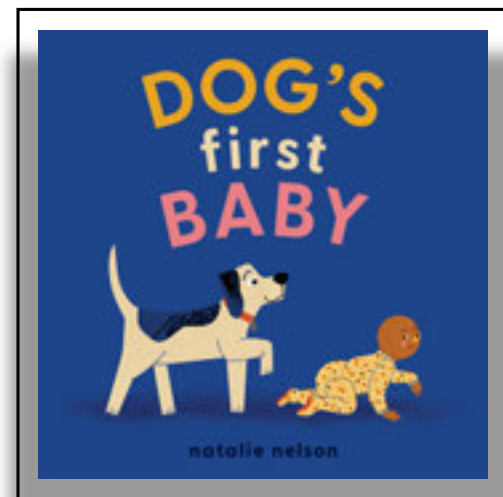

## Quirk Books, October 2021

AGE RANGE: 2 to 5

SPECS: 28 pages, 7" x7" - 4 color board book

SUBJECT AREAS:

BISAC 1: Juvenile Nonfiction – Family – New Baby

BISAC 2: Juvenile Nonfiction – Animals - Dogs

BISAC 3: Juvenile Nonfiction – Animals - Pets

Over 35,000  
copies sold  
since 2021!

### About the book:

A playful and heartwarming board book from the perspective of a skeptical dog who must come to terms with--and maybe even become friends with--a peculiar new family member. Perfect for dog loving families and new parents!

Dog likes his routines: spending time with his humans, eating, sleeping, and playing. But one day, the arrival of a new being changes everything. It's hard to know what this creature is--is it a dog, or something else?--but as Dog investigates, he may come to appreciate his loud, silly new sibling. She does drop food on the ground, after all.

With *Dog's First Baby*, Natalie Nelson captures the wonder and humor of a new family member through a dog's eyes. Sure to delight kids and dog parents alike, this board book promises to be a repeat readaloud.



## About the Author



**Natalie Nelson** is an illustrator, picture book maker, and collage artist. Trained in graphic design and illustration, she works in a mixed media hybrid of cut paper, collage, and digital art, with an emphasis on intriguing shapes, textures, and layers. Her previous titles include *Dog's First Baby* (Quirk 2021) and *Holiday!*. Her art is in demand from national clients including *The New York Times*, *The Washington Post*, *Time Magazine*, *Curbed*, *Eater*, *The Bitter Southerner*, Teach for America, Vox Media, Mailchimp, and more. She lives in Atlanta, Georgia with her husband, their dog, Coach, and their baby.

**Site:** [natalieknelson.com](http://natalieknelson.com) **Social:** @nelsonknatalie

Want to see more information?

- PDF and finished copies available now.
- Send an email to [rights@quirkbooks.com](mailto:rights@quirkbooks.com) now to register your interest and request full materials!

**MIDDLE  
GRADE**

Fiction

# A SPOONFUL OF TIME



## Spoonful of Time

By Flora Ahn

April 2023

*When You Reach Me* meets *Love Sugar Magic* in this unforgettable middle grade novel where time travel, family recipes, and family secrets collide.

### TARGET CONSUMER:

- 8-12 year old readers who enjoy magical realism and light scifi novels
- Immigrant parents and readers who are looking for books that reflect their cultural experiences
- Teachers & librarians looking for readalikes for fans of *LOVE SUGAR MAGIC* by Anna Meriano, *WHEN YOU TRAP A TIGER* by Tae Keller, and *WHEN YOU REACH ME* by Rebecca Stead

Rights sold: World English Audio (Blackstone)

For more info: [rights@quirkbooks.com](mailto:rights@quirkbooks.com)



## About The Book:

***When You Reach Me* meets *Love Sugar Magic* in this unforgettable middle grade novel where time travel, family recipes, and family secrets collide.**

Maya's grandmother, Halmunee, may be losing her memory, but she hasn't lost her magic touch in the kitchen. Whether she serves salty miyeok-guk or sweet songpyeon, her stories about Korea come to life for Maya.

Then one day, something extraordinary happens: one delicious bite transports Maya and Halmunee into one of Halmunee's memories. Suddenly they're in Seoul, and Halmunee is young.

This is just the first of many secrets Maya will uncover: that she and her grandmother can travel through time. As Maya eats her way through the past, her questions multiply—until a shocking discovery transforms everything she thought she knew about family, friendship, loss, and time itself.

Brimming with heart and interspersed with seven family recipes that readers can make themselves, this is a story to savor by rising Korean American author Flora Ahn.

## Key Selling Points:

- **COMPELLING FAMILY STORY WITH A MAGICAL TWIST:** Maya's connection with her grandmother, magical home-cooked meals, and buried family secrets make for a heartwarming page-turner.
- **THEMES OF IMMIGRATION AND HERITAGE:** Maya's multi-generational immigrant family explores the link between food, memory, and cultural heritage.
- **RECIPES YOU'LL WANT TO MAKE:** Includes several mouthwatering Korean recipes in illustrated section openers that readers will be inspired to try making!



## Praise for A SPOONFUL OF TIME:

“**Beautifully written**...the descriptions of the dishes are salivating enough that readers might appreciate the ability to recreate them at home. A **warm and satisfying** intergenerational story.”--*Booklist*

“**Full of twists**, this middle-grade story is a **heartwarming** mix of food and family.”  
—*Kirkus Reviews*

“Seasoned with humor and a rich setting, *A Spoonful of Time* is an **enchanted** novel about **family secrets, friendships, loss, and food** that transports us to the past. Warning: don't read while hungry!”—Lynne Kelly, author of *Song For a Whale*

“A **vividly written** tale that is easy to love, Flora Ahn's novel is intricate, enchanting, and absolutely brimming with life. This is a **surprising and timeless story**, with the perfect mix of **sweetness, wonder, and depth**.”—Corey Ann Haydu, author of *Eventown* and *One Jar of Magic*



## About the Author



**Flora Ahn** is an attorney by day and an author and illustrator by night. Her work includes a children's chapter book series, *Pug Pals* (Scholastic) and an Audible Original, *The Golden Orchard*. Raised in California by her Korean immigrant parents, Ahn lives in Virginia with her two pugs and practices law in Washington, DC.

## Specs and Data:

- **KEY DATES:** Final PDF Available Now. **Publication** April 2023
- **SPECS:** 272 pages, 5-1/2" x 8", 1 color, 8 small spot illustrations
- **SUBJECT AREAS:**
  - **BISAC 1:** Juvenile Fiction – Science Fiction – Time Travel
  - **BISAC 2:** Juvenile Fiction – Social Themes - Immigration
  - **BISAC 3:** Juvenile Fiction – Social Themes – Death, Grief & Bereavement
- **RIGHTS SOLD:** Audio to Blackstone



# HUNTERS OF THE LOST CITY

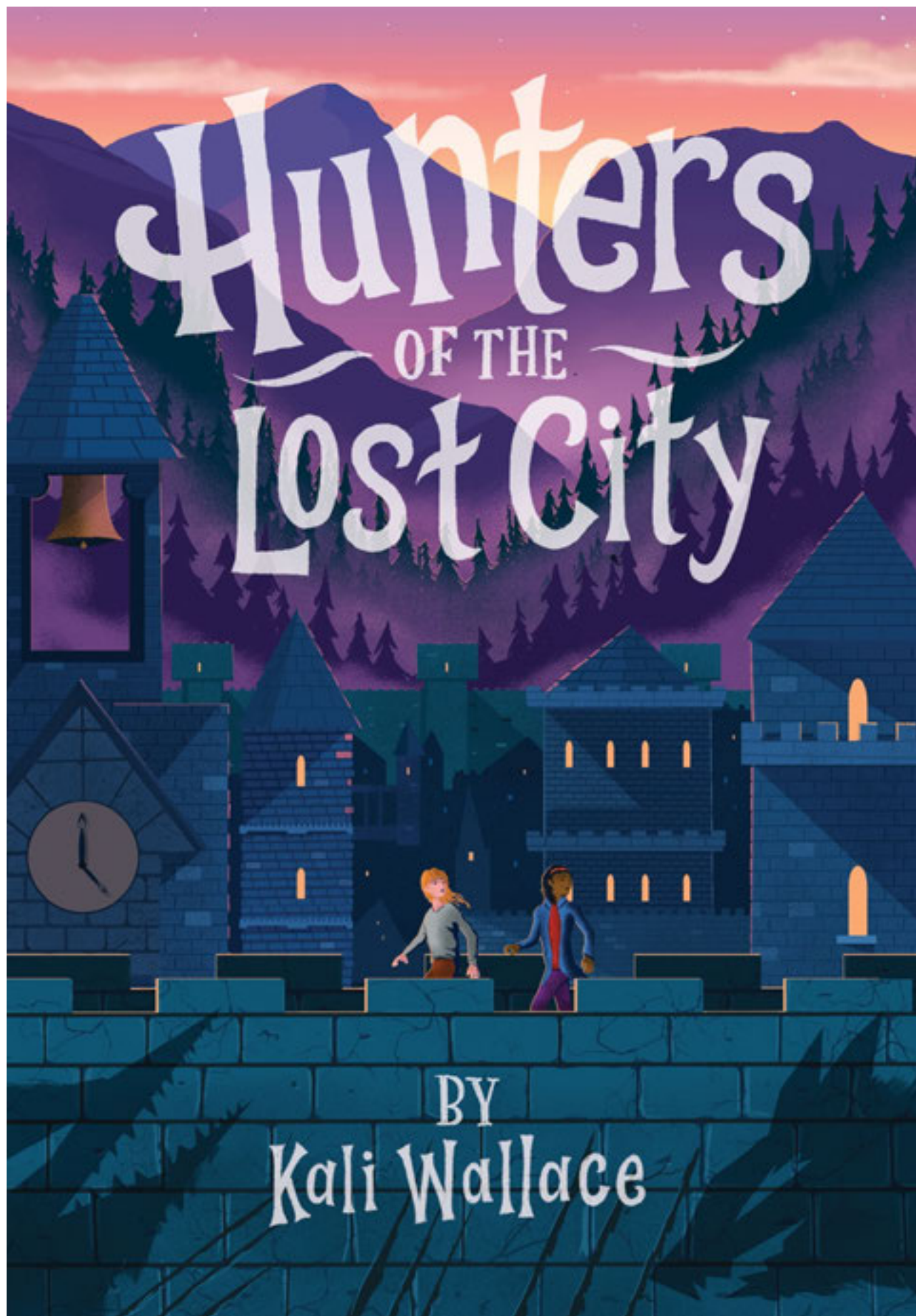

## Hunters of the Lost City

By Kali Wallace

April 2022

Twelve-year-old Octavia grew up believing Vittoria was the only town left in the world—until she escapes to face a land teeming with monsters, lies, and dark magic. Perfect for fans of Neil Gaiman, Kate Milford, and Jonathan Auxier.

### TARGET CONSUMER:

- Middle grade fantasy readers who love writers like Neil Gaiman, Kate Milford, Jonathan Auxier, and Tamora Pierce
- Librarians and teachers looking for a compelling fantasy read that engages with timely themes of disinformation and a “post-truth” world.

Rights sold: World English Audio (Blackstone), Korean (Gravitybooks)

For more info: [rights@quirkbooks.com](mailto:rights@quirkbooks.com)



## About The Book:

**Packed with shocking twists, frightening monsters, and dark magic, this is a page-turning fantasy adventure for middle-grade fans of Holly Black and Tamora Pierce.**

Twelve-year-old Octavia grew up believing the town of Vittoria was the only one left in the world. The sole survivors of a deadly magical war and plague, the people of Vittoria know there's no one alive outside the town walls—except the terrible monsters that prowl the forest.

But then the impossible happens: Octavia meets another girl beyond the walls, someone who isn't Vittorian. Everything she's ever believed is thrown into question, and there's no going back.

In her quest for the truth, Octavia discovers a world full of lies, monsters, and magic. She'll have to use every scrap of her skill, wits, and courage to uncover what's real about Vittoria and the rest of the world.

## Key Selling Points:

- **A WORLD TO GET LOST IN:** Readers who love Tamora Pierce and Neil Gaiman will find a similar sensibility in Kali Wallace's layered world of dramatic landscapes, compelling characters, and fascinating magic systems.
- **TIMELY—AND TIMELESS--THEMES:** Octavia's quest for the truth in a world that creates its own "facts" will be familiar to anyone who follows global politics. As kids and gatekeepers alike have grappled with what it means to live in a "post-truth" world, this riveting novel will offer entry points for discussion
- **CRITICALLY ACCLAIMED AUTHOR:** Wallace's adult scifi novels are published by Berkley, and her previous YA with HarperCollins. She has received numerous starred reviews and Junior Library Guild picks.



## Praise for HUNTERS OF THE LOST CITY:



"Reminiscent in feel to Kelly Barnhill's *The Girl Who Drank the Moon*, this lovely fantasy introduces **a complicated, brave, and believable heroine** navigating grief, friendship, and the possible first stirrings of a (same-sex) crush while asking **hard questions about power and community**. This quiet fantasy gem renews and refreshes an old chestnut of a premise. **An absolute delight.**"—*Kirkus Reviews*, starred review



"**A rare look at a post-apocalyptic world for the middle-grade set.** . . . Octavia, kind, brave, and insatiably curious, is a **compelling protagonist** to lead the way toward a new world."—*The Bulletin of the Center for Children's Books*

"I absolutely loved this book. Octavia is **a heroine for the ages.**"—Ronald L. Smith, award-winning author of *Hoodoo* and *Black Panther: The Young Prince*

"**Richly detailed magical lore, gripping action, and frightening fantastical creatures** are grounded by **well-rounded characters** and the girls' blossoming friendship."—*Publishers Weekly*

"A fantastical adventure through **a world of magic and monsters.** . . . A strong pick for fans of another **hard-to-put-down** fantasy about discovering truth, Kelly Barnhill's *The Girl Who Drank the Moon*."—*Booklist*



## About the Author



**Kali Wallace** studied geology and earned a PhD in geophysics before she realized she enjoyed inventing imaginary worlds more than she liked researching the real one. She is the author of science fiction, fantasy, and horror novels for adults, teens, and children, as well as a number of short stories and essays. She lives in the Pacific Northwest.

## Specs and Data:

- **KEY DATES:** Publication April 2022
- **SPECS:** 304 pages, 5-1/2" x 8", 1 color, 1 map, no illustrations
- **SUBJECT AREAS:**
  - **BISAC 1:** Juvenile Fiction – Fantasy & Magic
  - **BISAC 2:** Juvenile Fiction – Action & Adventure
  - **BISAC 3:** Juvenile Fiction – Visionary & Metaphysical
- **RIGHTS SOLD:** Audio to Blackstone, Korean to GravityBooks

# WARREN THE 13TH

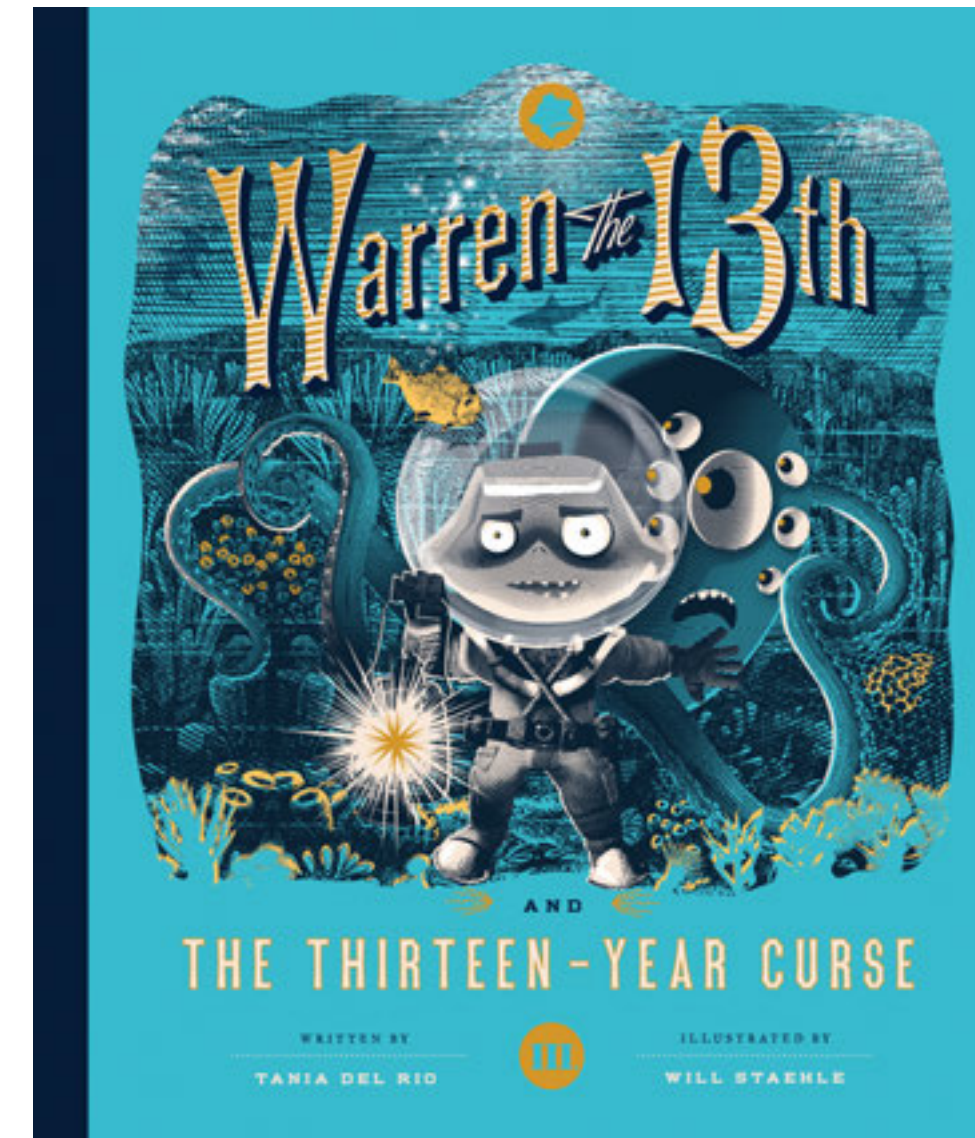
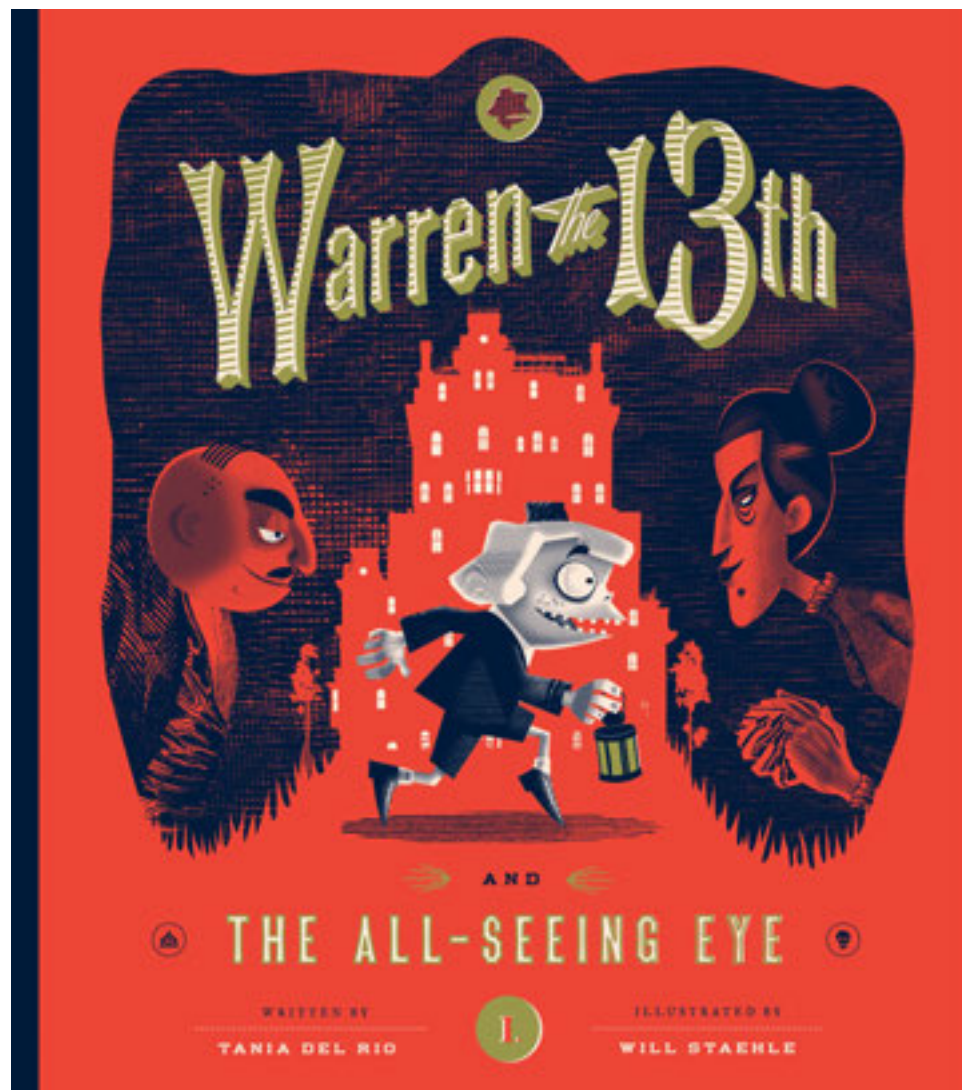

**About the Series:** A strange-looking kid with a heart of gold, fastidious orphan Warren has one dream: to restore his family's creepy old hotel to its former glory. But to do that, he has to contend with mysterious visitors, secret codes, hidden maps, weird creatures, and angry witches. Luckily Warren has friends to help him, including a witch-in-training, a circus strongman turned chef, a reclusive professor, and a friendly monster named Sketchy...all depicted in gorgeous illustrations on stunningly designed pages that will pull readers into Warren's fun and spooky world. **Age 10 and up.**

**Active Rights Sold:** English Audio (Book 1 only), Bulgarian, Czech Print, Czech Audio, Estonian, Finnish, German, Greek, Italian, Polish, Romanian, Russian, Slovak Audio, Spanish

**Expired Rights Sold:** French, Hungarian, Korean, Lithuanian, Persian, Brazilian Portuguese, Serbian, Slovak, Thai, Turkish

# NICK AND TESLA

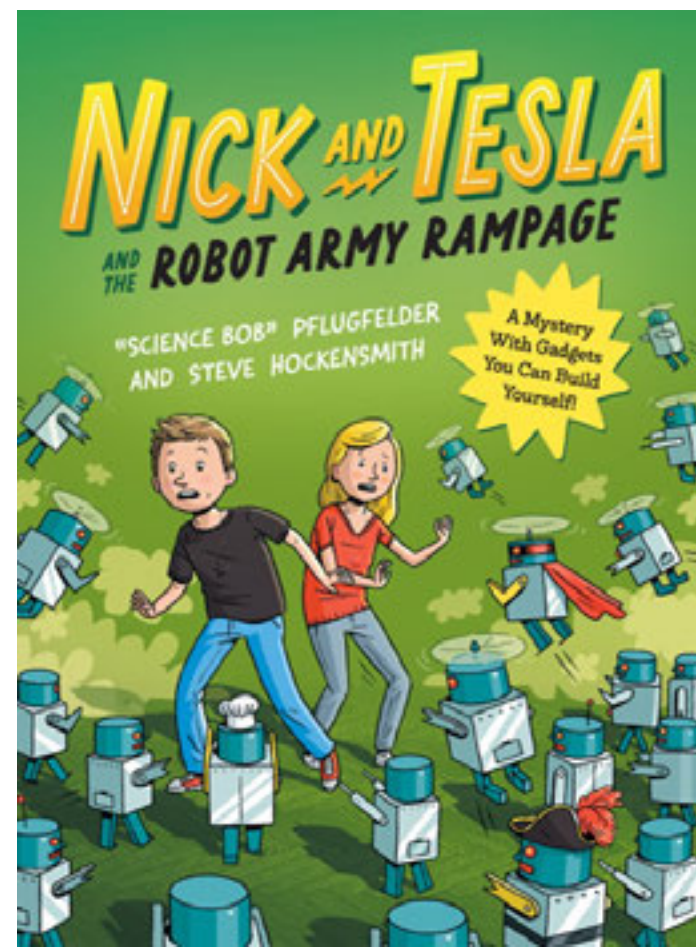
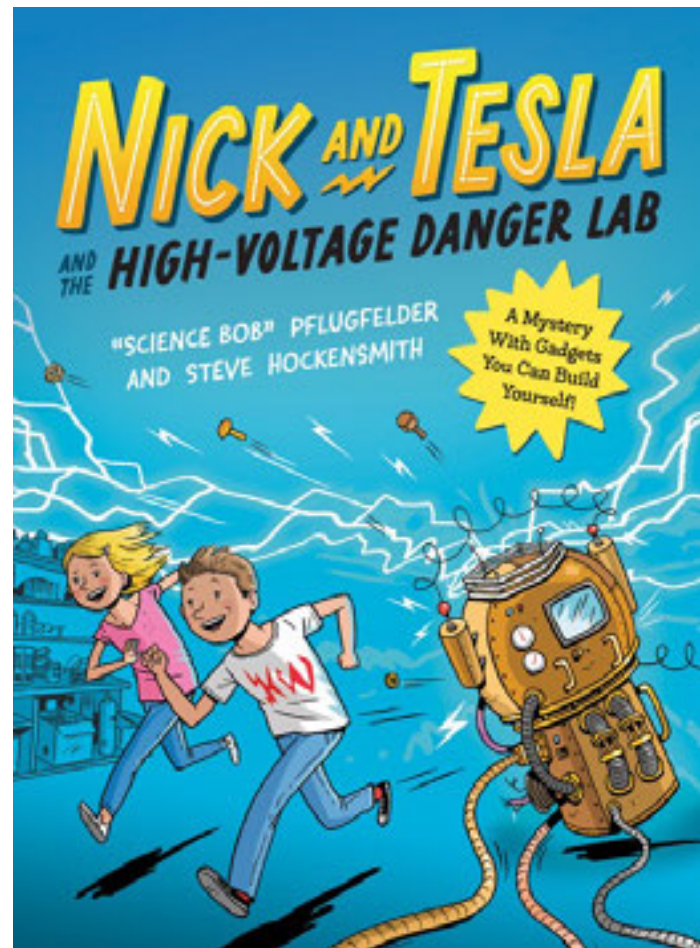

**About the Series:** When their parents send them to spend the summer with their eccentric scientist uncle, kid inventors Nick and Tesla Holt keep themselves busy by using their smarts to solve mysteries.

Each story includes easy-to-follow project instructions so young readers can build the same homemade gadgets that the Holt twins use in their adventures.

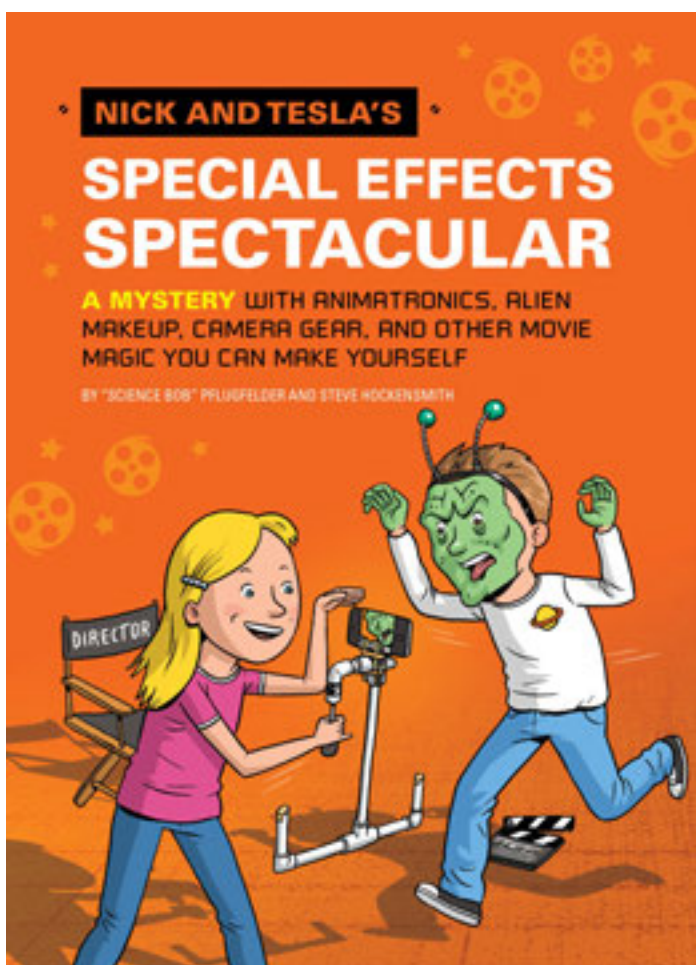

**Active Rights Sold:** Audio (Books 1 and 2 Only), Greek, Hungarian, Italian, Persian, Polish, Serbian, Turkish

**Expired Rights Sold:** Indian English, Chinese (S), Czech, Korean, Romanian

# NICK AND TESLA REJACKETS

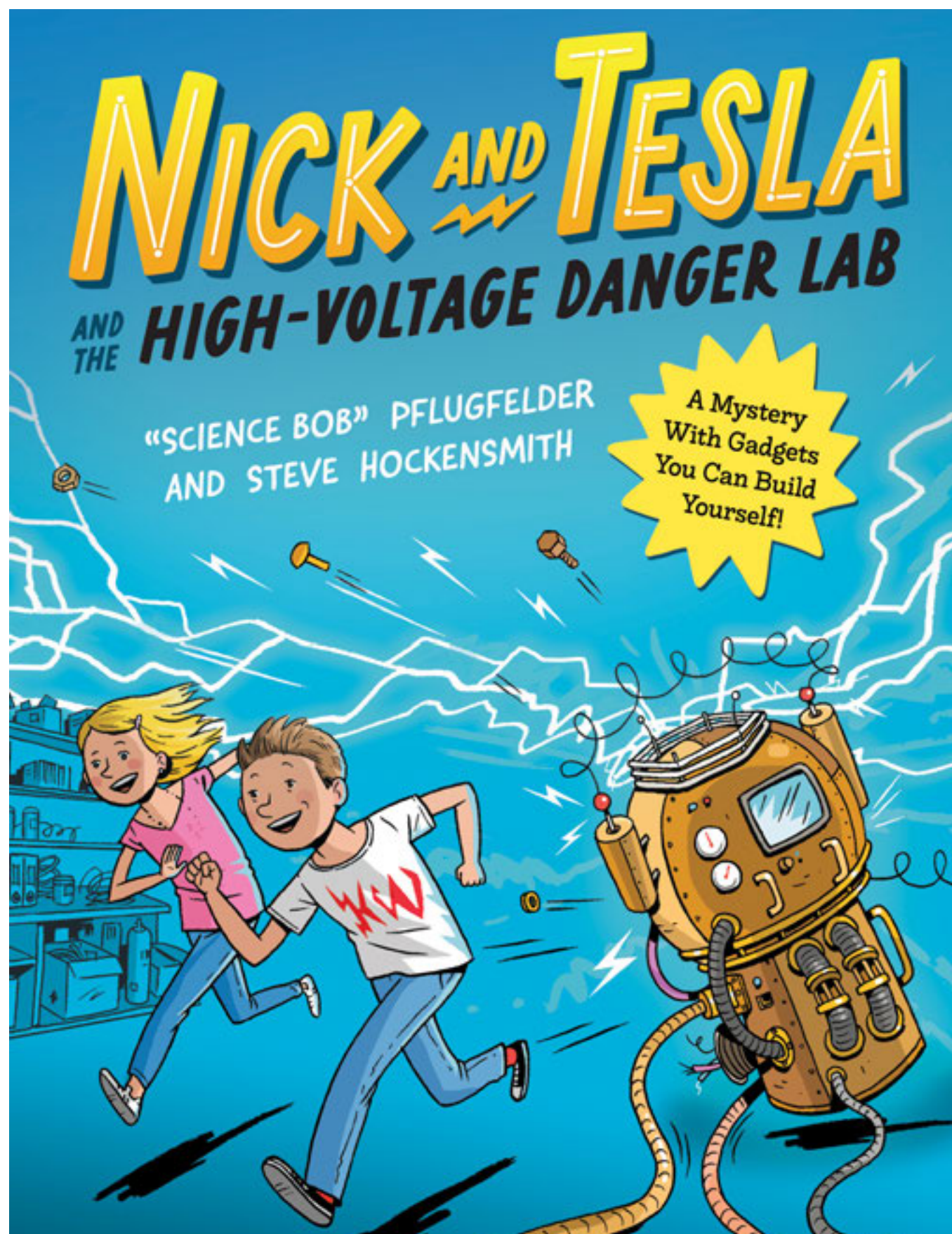

Solve mysteries using DIY science projects with twin sleuths Nick and Tesla in this zany, action-packed middle grade adventure by Science Bob!

Summer break is about to get weird. After their parents disappear, twins Nick and Tesla are sent to live with their Uncle Newt, an eccentric inventor with his very own science lab. Soon, the young sleuths find themselves investigating a mysterious family right in their own neighborhood. As they race to uncover the truth, Nick and Tesla must build a bottle rocket launcher, a 9-volt battery burglar alarm, and an electromagnet picker-upper to save the day.

**Now in paperback**, the first book in the popular Nick and Tesla series features laugh-out-loud jokes, fun illustrations, and five DIY science projects with step-by-step instructions for readers to try at home.

**50,000 copies sold of hardcover edition!**

## About the Authors:

**“Science Bob” Pflugfelder** is an elementary school teacher based in Newton, Massachusetts. He has made many television appearances to get kids excited about science. These are his first books.

**Steve Hockensmith** is the author of a *New York Times* bestseller and an Edgar award nominee.



## CHAPTER 1

Someone climbed into Joe Devlin's cab, and he put down his newspaper and looked in the rearview mirror and started to say "Where to?"

He froze.

Sitting behind him were a boy and a girl with sad, serious expressions on their faces. They looked like they were eleven or twelve years old.

There were no adults in sight.

Two kids getting into a taxi, alone, outside San Francisco International Airport?

Trouble, Joe's gut said.

The boy looked down at a letter he was holding. "Five-thirteen Chesterfield Avenue," he said.

~ 6 ~

Joe could hear the paper rustling as he spoke. The boy's hands were shaking.

"In Half Moon Bay," the girl said, her voice firm, resolute. "That's near here, right?"

Joe turned around to squint at his would-be passengers. They were dressed like any other kids—T-shirts, jeans, sneakers—yet they seemed subdued and grave in a way that didn't fit their ages. All they had with them were the letter and two small, black suitcases and a book each.

The boy was holding something called *A Brief History of Time*. The girl had *Theory of Applied Robotics: Kinematics, Dynamics, and Control*.

"You're not running away, are you?" Joe said. "Where are your parents?"

"No, we're not runaways," the girl said. "Our parents are . . . well . . ."

"They're in Uzbekistan," said the boy.

Joe blinked.

"Uzbekistan?" he said.

The boy nodded. "Watching soybeans grow."

"Well," the girl said, "it's a little more complicated than that."

"Oh," said Joe. "Oooooookay."

~ 7 ~

"Well . . ." Nick began.

"Wait," said Tesla. "What is that orange gunk? And how'd you get stuck to the floor in it?"

Uncle Newt's eyes lit up with excitement.

"Gunk?" he said, waving a hand at the goo on his back. "This isn't gunk! It's the future!"

Nick and Tesla looked at each other as Uncle Newt wobbled awkwardly toward the nearest worktable. (The back of his jeans was still coated in stiff orange foam.) Their father had always told them that his older brother was "a self-employed inventor." But it looked to Nick and Tesla like another job description would fit even better.

Their uncle was a mad scientist.

"Observe!" Uncle Newt said, snatching up the spray bottle filled with orange liquid and whirling around to face the kids (and nearly losing his balance again in the process). He pointed the bottle at the back of his left hand and squeezed.

Vapor shot from the nozzle and coated his skin in a layer of spongy orange. Uncle Newt kept spraying, turning his hand this way and that until it was covered evenly all the way around.

"What do you think I'll have once this dries?"

~ 28 ~

he said.

"An orange hand?" Nick said.

"Yes. And . . .?"

"An orange glove," said Tesla, looking impressed. Uncle Newt grinned, delighted.

"Exactly!" He shook the spray bottle. "Instant spray-on clothes!"

The spongy orange "glove" on Uncle Newt's hand kept expanding until it looked more like an orange mitten, and then a puffy orange boxing glove.



## NICK AND TESLA'S LOW-TECH (PRACTICALLY NO-TECH) BOTTLE ROCKET AND LAUNCHER

### THE STUFF

- 3 pieces of 10-inch (25.5-cm) PVC pipe (labeled 1/2 inch [1.25 cm] wide at hardware stores) (A)
- 3 pieces of 20-inch-long (51 cm) PVC pipe (B)
- 3 90-degree-angle pieces (C)
- 1 T connector (D)
- 2 end caps (E)
- 1 threaded end cap (F)
- 1 bicycle pump (G)
- 1 TRN13 tire valve (can be acquired from an auto parts store or a garage that fixes tires) (H)
- 1 1- or 2-liter plastic soda bottle (I)
- Water
- Electrical tape
- PVC cement
- A drill
- Pliers
- Safety goggles

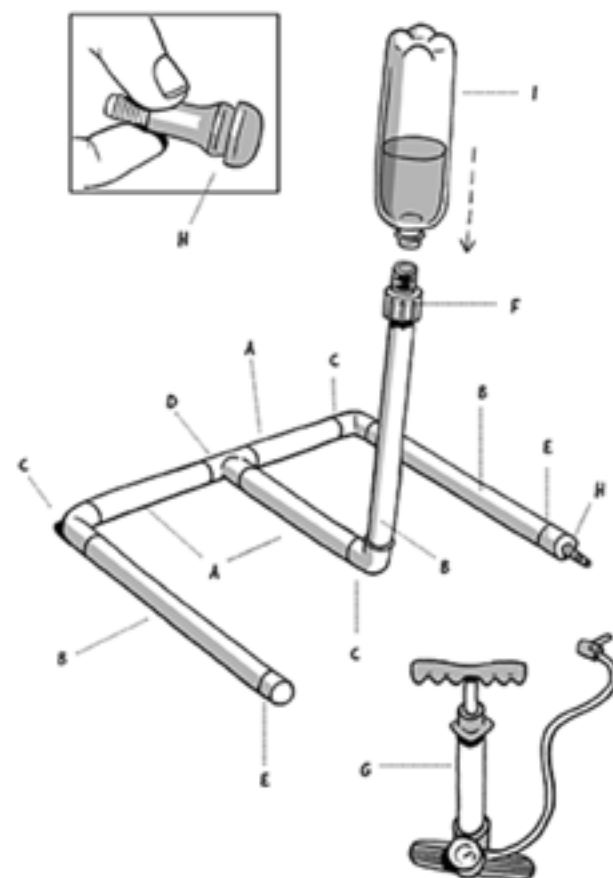

### THE SETUP

1. Ask an adult to drill a 1/2-inch (1.25-cm) hole into the center of the flat side of one of the caps.
2. Feed the valve through the hole from the inside of the cap. Use the pliers to pull the valve through the hole so that the cap sits in the groove at the base of the valve. It may take a little twisting and tugging.
3. Gather the pipe, angle, and connector pieces together and lay them out as shown in the illustration. Working with an adult, follow the directions on the PVC cement to attach all the pieces snugly.
4. Let the completed launcher dry for as long as possible, preferably overnight.
5. The bottle goes over the vertical pipe in the middle. Wrap electrical tape around the threaded end cap until you get a tight fit when you place the neck of the bottle over it.
6. Go outside and make sure your launch area is clear of people and obstacles.

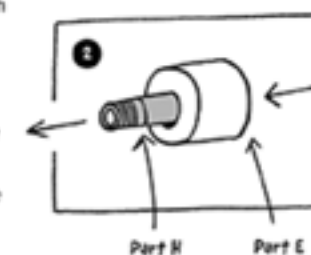

7. Fill the bottle one-third to halfway with water.
8. Turn the launcher upside down and twist the bottle snugly onto it.
9. Turn the launcher right side up and attach the bicycle pump securely to the valve.

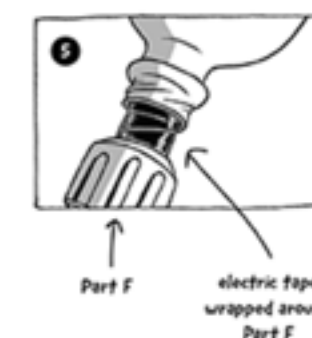

### THE FINAL STEPS

1. Put on your safety goggles and start pumping.
  2. Be ready for the pressure to send the rocket flying!
  3. If the rocket launches too soon (or doesn't go very high), add more electrical tape around the threaded end cap to create a tighter seal against the bottle.
- WARNING:** Never stand over an unlaunched rocket. If the rocket fails to launch after excessive pumping, it's possible the electric tape seal is too tight. Remove the pump from the tire valve. Then push the small pin inside the valve until all the air has been released (much as you would flatten a bicycle tire). Have an adult remove the bottle. Peel off three layers of electric tape from the launcher and give it another go.



# NICK AND TESLA REJACKETS

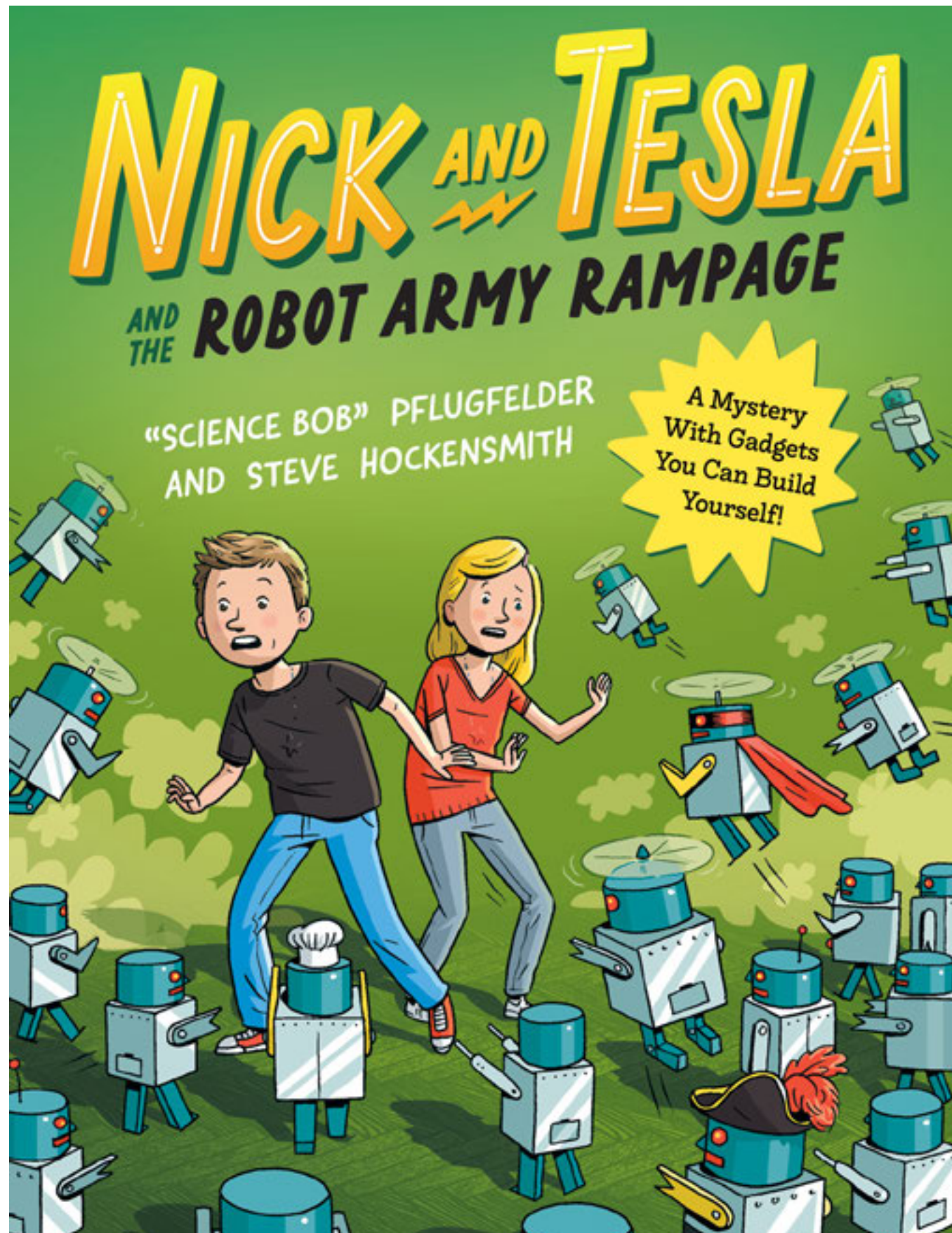

Join twins Nick and Tesla as they build homemade robots and race to solve a mystery in this zany, action-packed middle grade adventure sequel.

It's up to Nick and Tesla to save the day—again! When a rash of robberies hits the town of Half Moon Bay, the two young sleuths head straight to their Uncle Newt's science lab. They'll have to build their very own battlebots, robo-bugs, and hoverbots to outsmart a criminal mastermind. Can Nick and Tesla crack the case before it's too late?

Now in paperback, this second book in the popular Nick and Tesla series features laugh-out-loud jokes, fun illustrations, and five DIY science projects with step-by-step instructions for readers to try at home.

25,000 copies sold in hardcover!

## About the Authors:

**"Science Bob" Pflugfelder** is an elementary school teacher based in Newton, Massachusetts. He has made many television appearances to get kids excited about science. These are his first books.

**Steve Hockensmith** is the author of a *New York Times* bestseller and an Edgar award nominee.



## CHAPTER 1

Nick was in the lab in the basement making a volcano with vinegar and dish-washing liquid.

Tesla was in the lab in the basement making a rocket with vinegar and baking soda.

Uncle Newt was in the lab in the basement making a compost-fueled vacuum cleaner out of a leaf blower and a bag of putrid bananas.

It was the vacuum cleaner that exploded.

Fortunately, the Banana Vac 8000 began sizzling and melting before exploding, giving Uncle Newt time to groan, "Aww, man. Not again."

Nick and Tesla knew what that meant. They put down their beakers, test tubes, and tongs and

hurried toward the rickety stairs. They had to do a lot of zigzagging, as the dimly lit basement was packed with old computers and grimy tools and abandoned inventions (a rocket-powered skateboard here, a gumball machine stocked with goldfish there) and, along the walls, mysterious contraptions that hummed and throbbed and occasionally went *ping*. Some of the machines were scorched. All were covered with soot.

"Come on, Uncle Newt!" Nick said as he and his sister began bounding up the steps.

Uncle Newt was the kind of man who needed to be reminded that it's a good idea to leave when a vacuum cleaner is about to explode.

"I just don't understand," he said as he reluctantly rose from his cluttered worktable and followed his niece and nephew. "I had the oxygen/methane mix perfect this time."

"That's what you said *last* time," Tesla pointed out.

"I know! It was perfect then, too."

Nick and Tesla scrambled up to the landing at the top of the stairs and turned to find their uncle plodding along behind them.

"Uhh, Uncle Newt?" said Nick. "Maybe you

want to move a little faster?"

Uncle Newt swiped a hand at him dismissively. "Oh, I've still got at least five more seconds to get away. Maybe even six. Well, four now."

The kids retreated into the kitchen, and slowly, serenely, he followed them.

"Two," he said. "One."

Nick, Tesla, and Uncle Newt stood for a moment, staring at each other. Then there was a *whomp* that shook the whole house.

"See?" Uncle Newt said. "There was plenty of time."

Smoke rose from the basement. It smelled like a hundred burned banana cream pies sitting in the sun at the county dump.

"Eewww," said Uncle Newt, grimacing and pinching his nose. "That's even worse than usual. Come on."

He led the kids out to the backyard, leaving the door open so the smoke could swirl out instead of filling the house. Uncle Newt's hairless cat, Eureka, trotted after them, curled up on the porch, and began licking ash off his wrinkled, bald butt.

It was a bright, warm summer day, and one of



Uncle Newt's neighbors—a genial old man Uncle Newt always called Mr. Blackwell, even though his name was Jones—was mowing his lawn nearby.

Mr. Jones stopped his mower and pointed his inch-thick glasses at Uncle Newt and Nick and Tesla.

"Need me to call the fire department again?" he said.

"No thanks, Mr. Blackwell," Uncle Newt told him. "It's just a methane-rich banana mash reacting

## TESLA'S DO-IT-YOURSELF SEMI-INVISIBLE BOTTLE BOT

### THE STUFF

- 1 battery holder for 2 AAA batteries (A)
- 1 3-volt motor (available from most electronics stores; the RadioShack catalog number is 273-223) (B)
- 2 wire coat hangers
- 1 plastic 2-liter water bottle
- 2 plastic bottle caps
- 2 small metal washers
- 2 AAA batteries
- Hot-glue gun
- Wire cutters
- Pliers
- Scissors
- Duct tape
- Extra wire, nuts, bolts, and other spare pieces

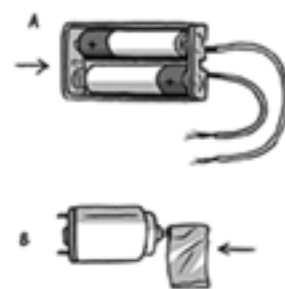

### THE SETUP

1. Use the wire cutters to cut the hangers into sections about 14 inches (35.5 cm) long.
2. Use the pliers to bend each section of wire in the middle so that the curve of the wire matches the curve of the water bottle.
3. Adjust the bend so that each "leg" is even.
4. Bend the end of each wire to give your robot "feet."

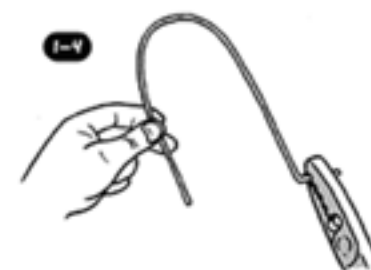

5. Test-fit the wire onto the bottle.
6. Hot-glue one wire onto the front of the bottle and the other onto the back.
7. Clip the wires if needed so that all four ends are the same length (this will help your robot stand on a flat surface).

8. Hot-glue the battery holder to the bottom of your robot so that the wires face toward the back of the bot.
9. Use scissors to cut a strip of duct tape about 1/2 inch (1.25 cm) long.
10. Fold the tape over the axle of the motor, making sure that the tape and axle spin freely.
11. Add another seven pieces of tape securely on top of the first. This will cause the motor to vibrate when it spins.



### THE FINAL STEPS

1. Remove 1/4 inch (2 cm) of the plastic from the ends of the battery holder wires and twist the wire onto one of the metal tabs of the motor. Repeat with the other wire and the other motor tab.
2. Hot-glue the motor onto the end of your robot, ensuring

that the tape can spin fully without hitting the bottle.

3. To make eyes, glue a small metal washer onto each bottle cap and then glue the caps onto the front of the robot.
4. Use lightweight wire, nuts, bolts and other roboty-looking pieces to decorate your bot. Filling the bottle with tangles of wire creates a nice colorful effect.
5. Add batteries, and the robot is ready to go! Tip: If your robot only goes backward, add some weight toward the front.

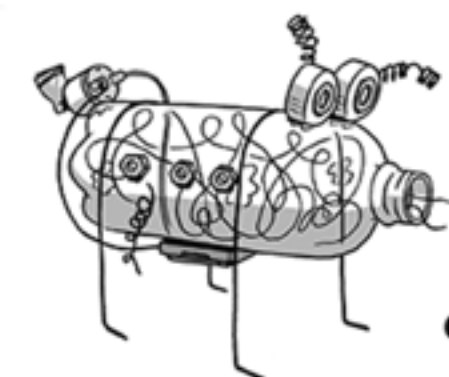

# LOVECRAFT MIDDLE SCHOOL



## About the Series:

“Two-headed monsters, giant tentacles, angry demons – *Lovecraft Middle School* is great creepy fun!” –Ransom Riggs, author of *Miss Peregrine's Home for Peculiar Children*

Strange things are happening at Lovecraft Middle School. Rats are leaping from lockers. Students are disappearing. The school library is a labyrinth of secret corridors. And the science teacher is acting very peculiar – in fact, he just might be a monster-in-disguise. Twelve-year-old Robert Arthur knew that seventh grade was going to be weird, but this is ridiculous!

Active Rights Sold: French, Italian

Expired Rights Sold: Czech, Hungarian, Russian, Slovak, Spanish, Swedish, Turkish

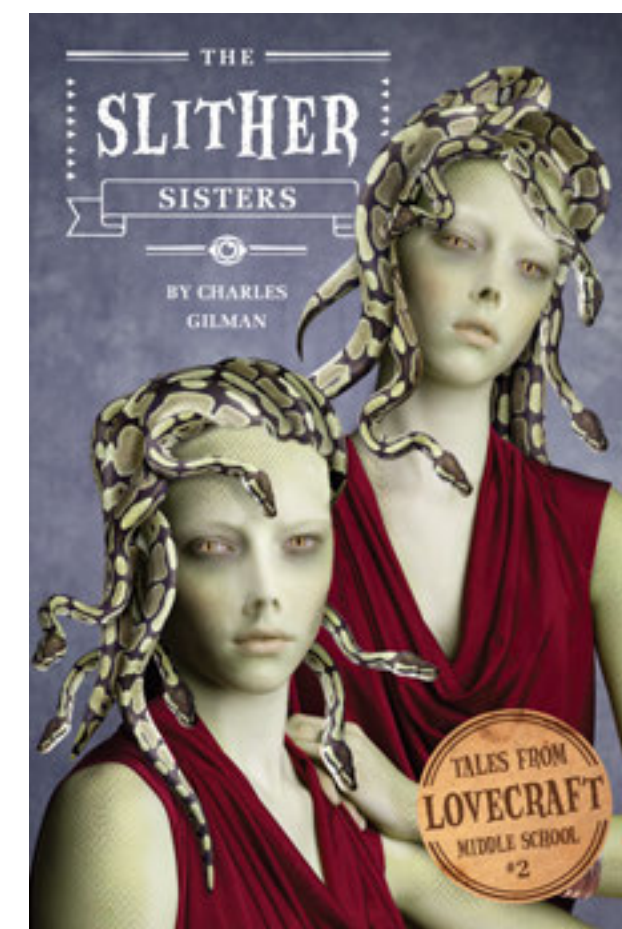
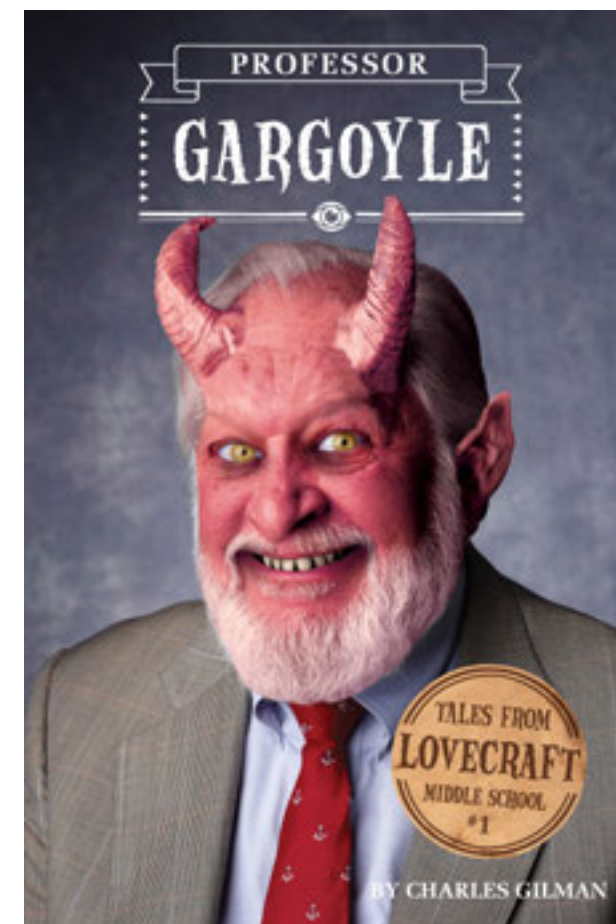

# WCS ULTIMATE ADVENTURES



## About the Series:

You decide how to survive in these pick-your-own-path, multi-plot adventures!

Are you ready for a page-turning, adrenaline-inducing, edge-of-your-seat reading experience? In this middle grade adventure series from the creator of the worldwide best-selling *Worst Case Scenario* books, you decide how to survive! There are over 20 possible endings, but only 1 ultimate success. Each story features vivid comic-book-style illustrations and real-life facts about survival and science from experts in extreme environments—perfect for anyone craving an adventurous reading experience. Do you have what it takes to survive?

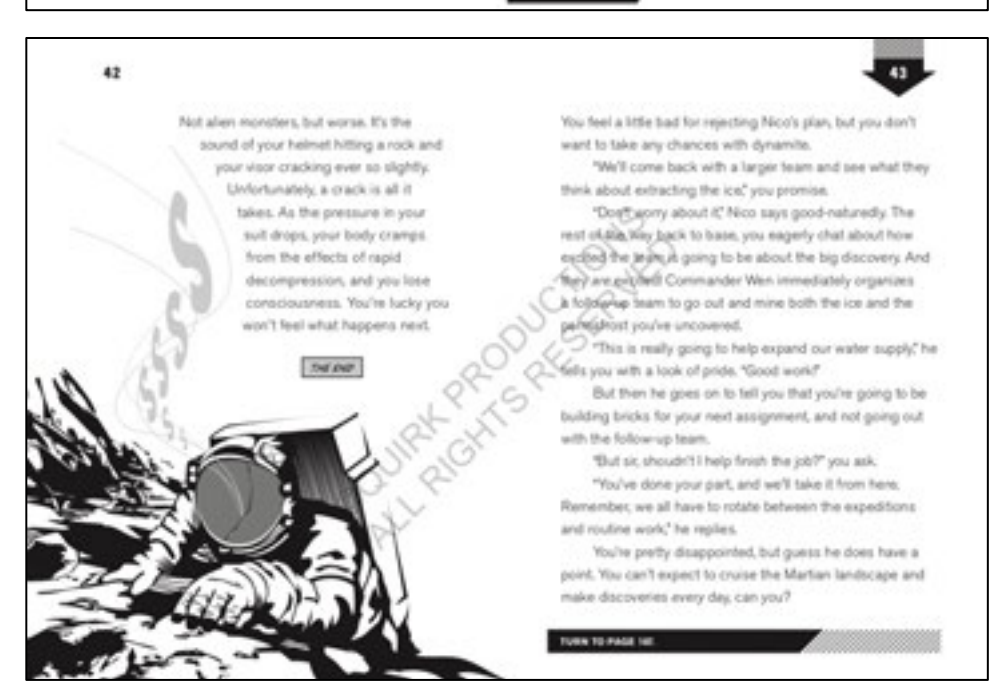
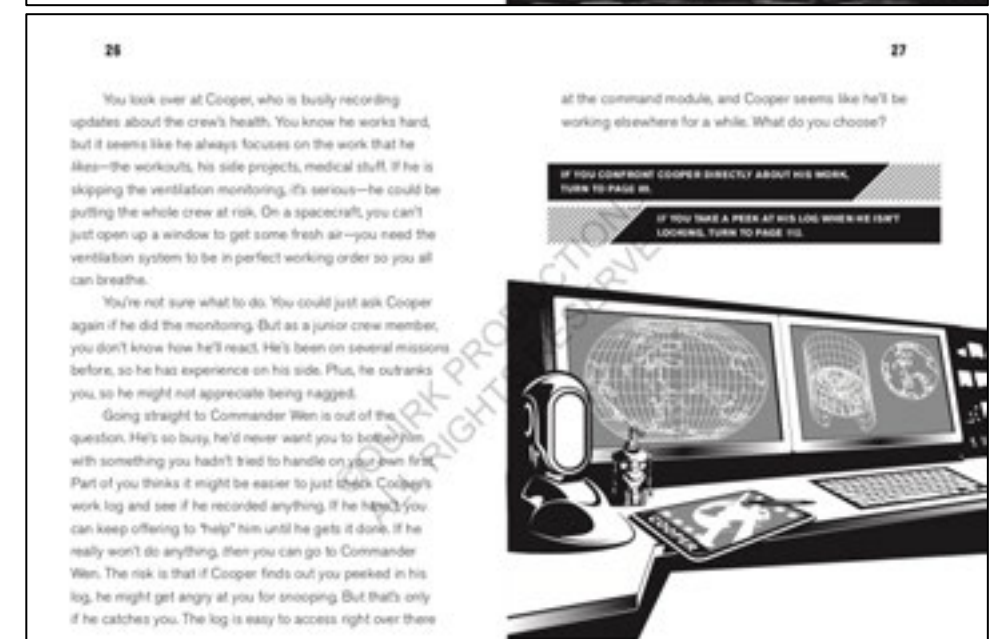
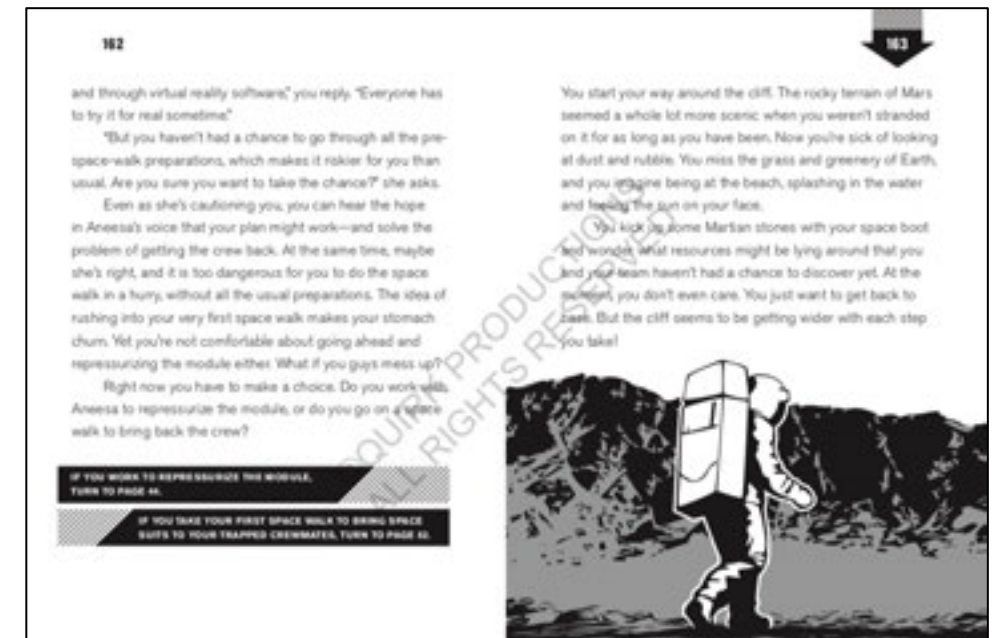
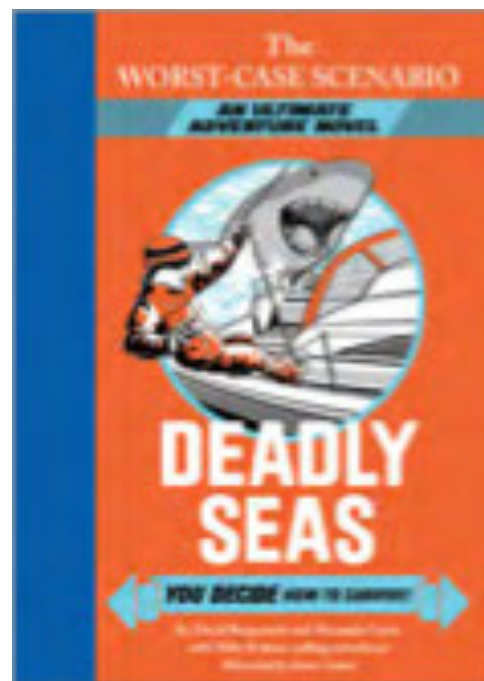
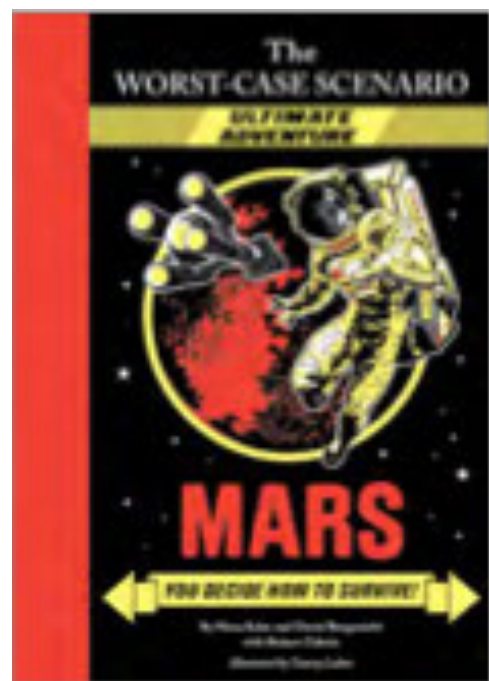

**MIDDLE  
GRADE**

Non-Fiction

# TOTALLY FACTUAL FIELD GUIDES TO THE SUPERNATURAL

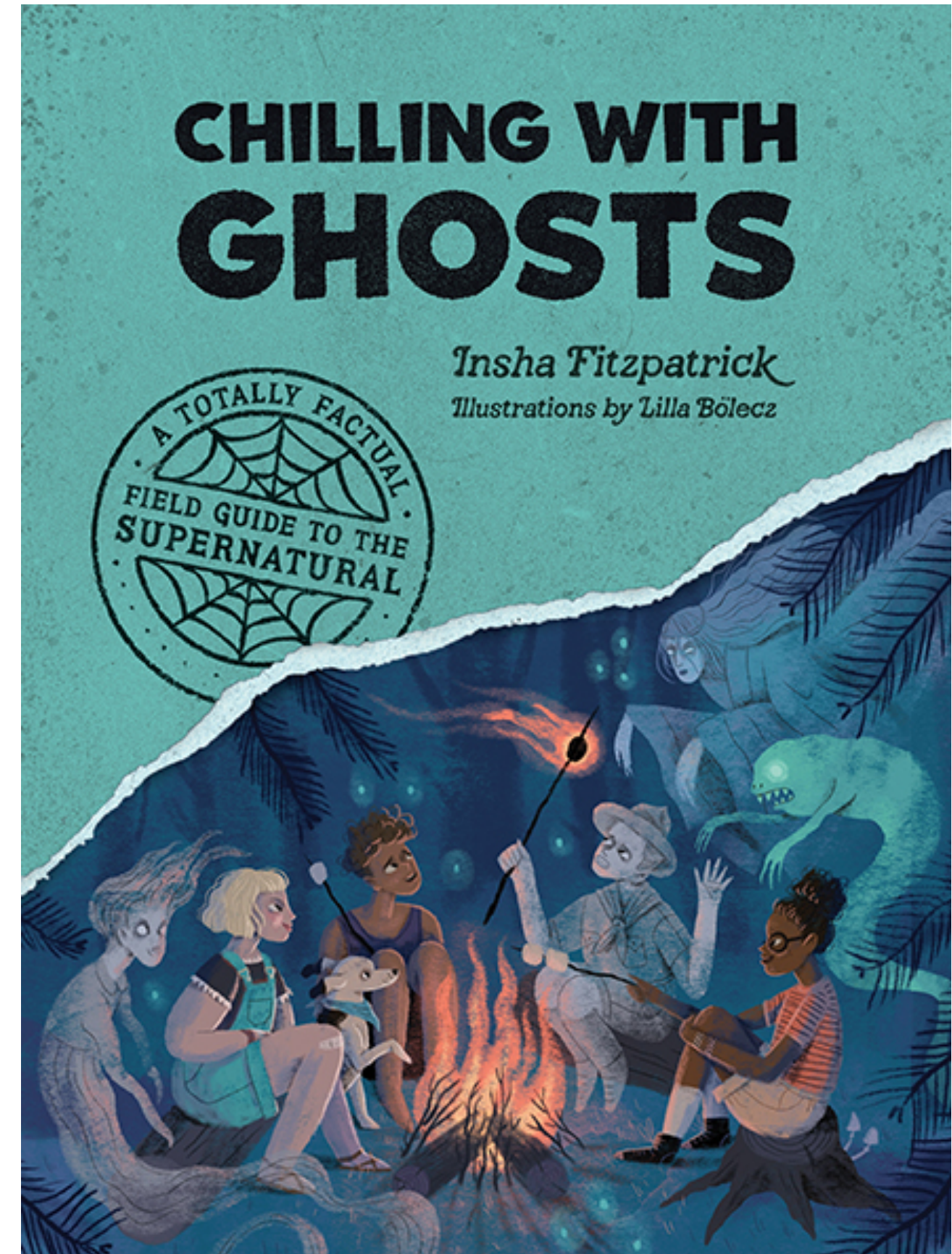
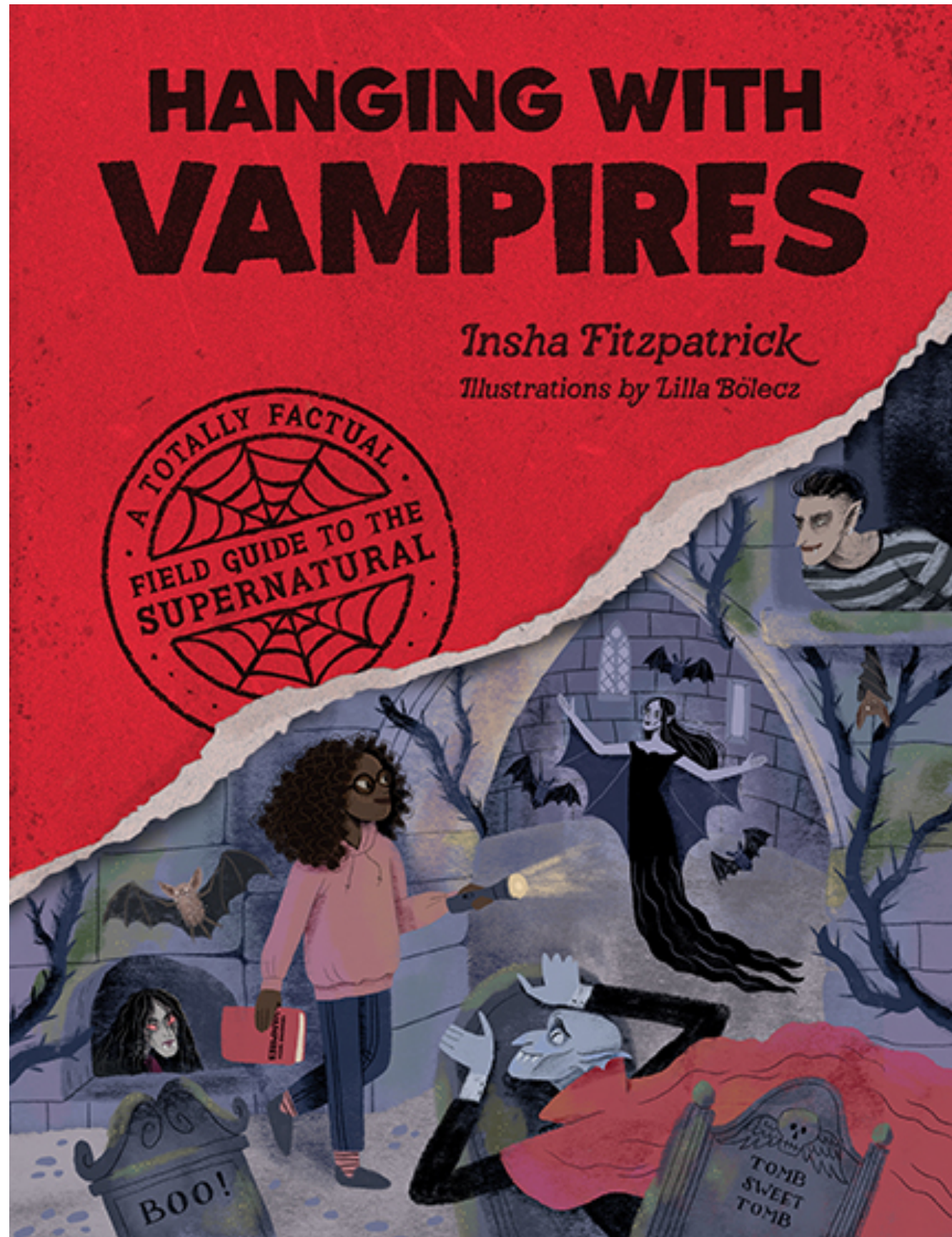



## Introducing our new **TOTALLY FACTUAL FIELD GUIDES TO THE SUPERNATURAL!**

- A spooky and laugh-out-loud nonfiction series perfect for young fans of mythology, *A Totally Factual Field Guide to the Supernatural* takes a field guide approach to the myths and legends that haunt our imaginations. Captivating tales, engrossing science, and fascinating history come to life with whimsical illustrations and kid-friendly text.
- Inclusive tales cover myths from Asia, Africa, Europe, the Americas, and from the past & present day!

### **About the author and illustrator:**

- **Insha Fitzpatrick** is a New Jersey-based author who loves all things horror. She's the writer of *Who Sparked the Montgomery Bus Boycott: Rosa Parks* (Who HQ), illustrated by Abelle Hayford. She's also the cowriter of the middle-grade graphic novel series *Oh My Gods!* with Stephanie Cooke and illustrator Juliana Moon. When she's not writing, she's watching horror movies or reality TV and deep-diving into all things true crime.
- **Lilla Bölec** is a Hungarian graphic artist and illustrator whose passion is creating peculiar, thought-provoking, and mystical scenes and characters inspired by, among other things, nature and mythology.

# HANGING WITH VAMPIRES

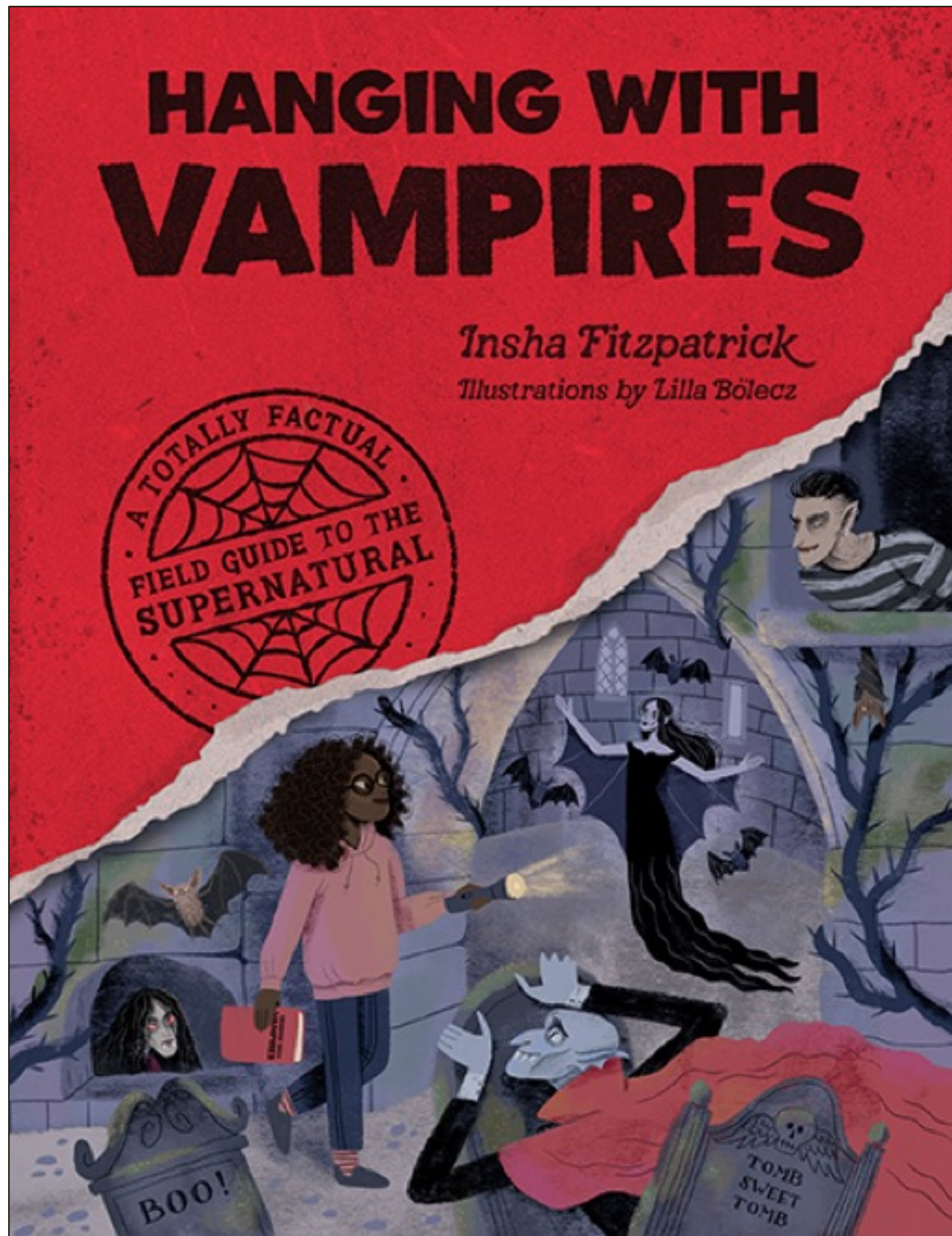

## Hanging With Vampires

By Insha Fitzpatrick

Illustrated by Lilla Bölecz

March 2023

Discover everything about vampires in this laugh-out-loud nonfiction handbook packed with spooky legends, fascinating history, and weird facts perfect for middle-grade readers and mythology fans!

Italian rights under negotiation. All other translation rights available.



Register your interest and request review materials: [rights@quirkbooks.com](mailto:rights@quirkbooks.com)





CONTENTS	
<b>Introduction</b> <i>Are vampires real?</i>	00
<b>Chapter 1: Vampires 101</b> <i>So what is a vampire, anyway?</i>	00
<b>Chapter 2: How to Fight a Vampire . . . and Win!</b> <i>You know, just in case, it never hurts to be prepared.</i>	00
<b>Chapter 3: Vampires Through the Ages</b> <i>Who knew history could be so scary?</i>	00
<b>Chapter 4: It's a Big World, After All</b> <i>Look alive! Meet seven undead supernatural entities from around the globe.</i>	00
<b>Chapter 5: Bloodsuckers and Bookworms</b> <i>Get sucked into vampire literature and—hey, is that Dracula?</i>	00
<b>Chapter 6: Lights, Camera, Vampires!</b> <i>The completely true tale of how vampires conquered Hollywood.</i>	00
<b>Conclusion</b> <i>Wait, so ARE vampires real?!</i>	000
<b>Further Reading</b>	000
<b>Bibliography</b>	000

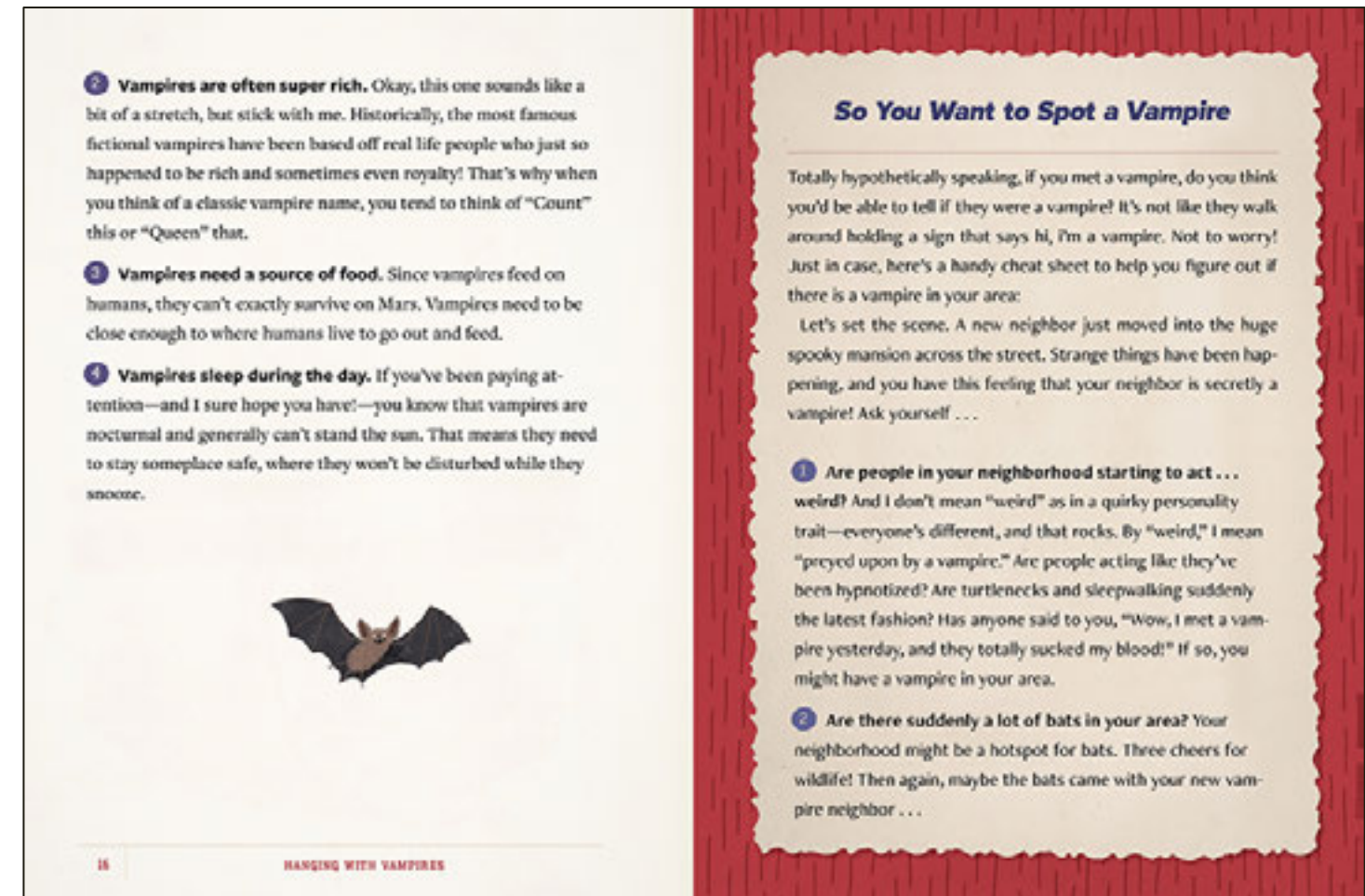
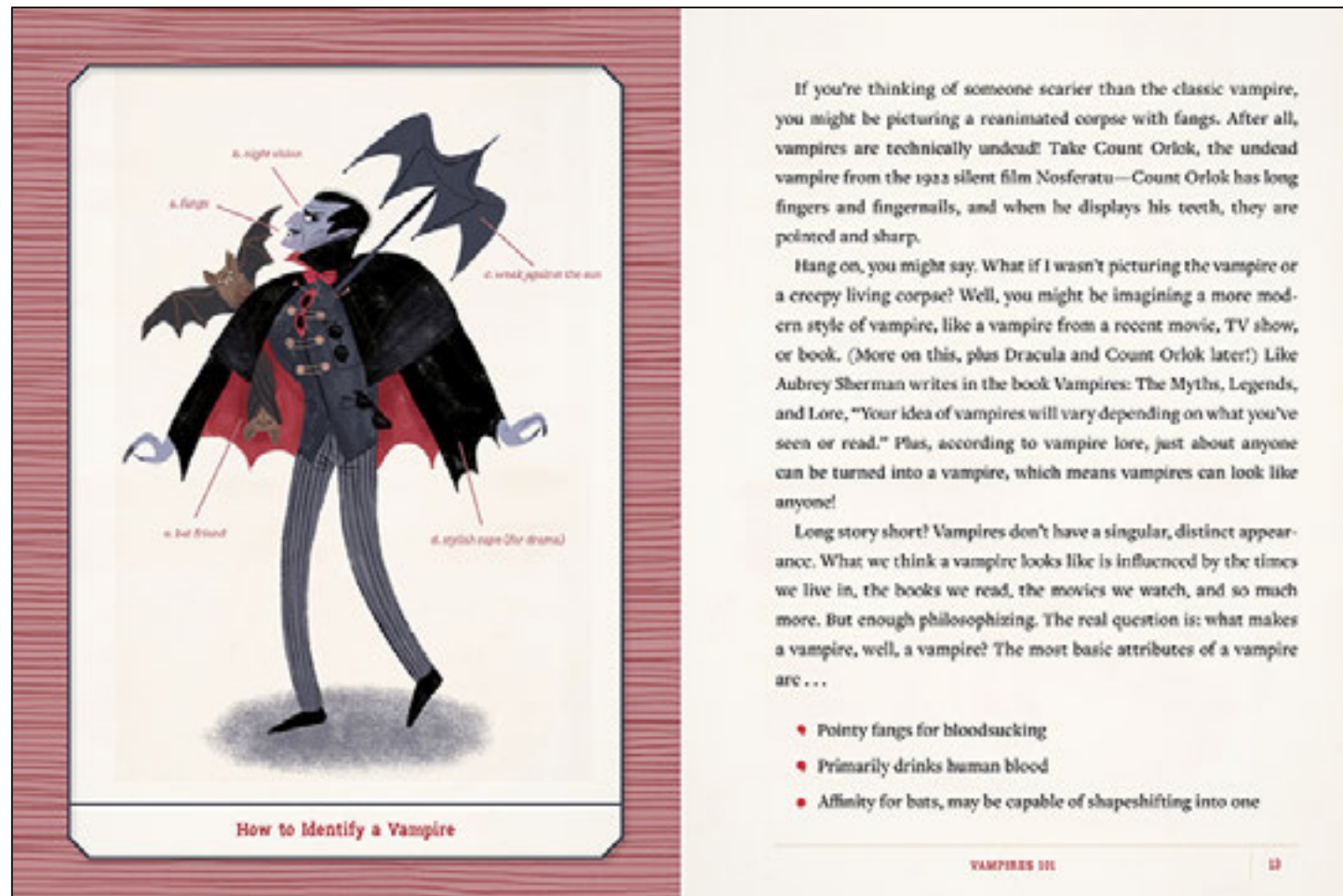
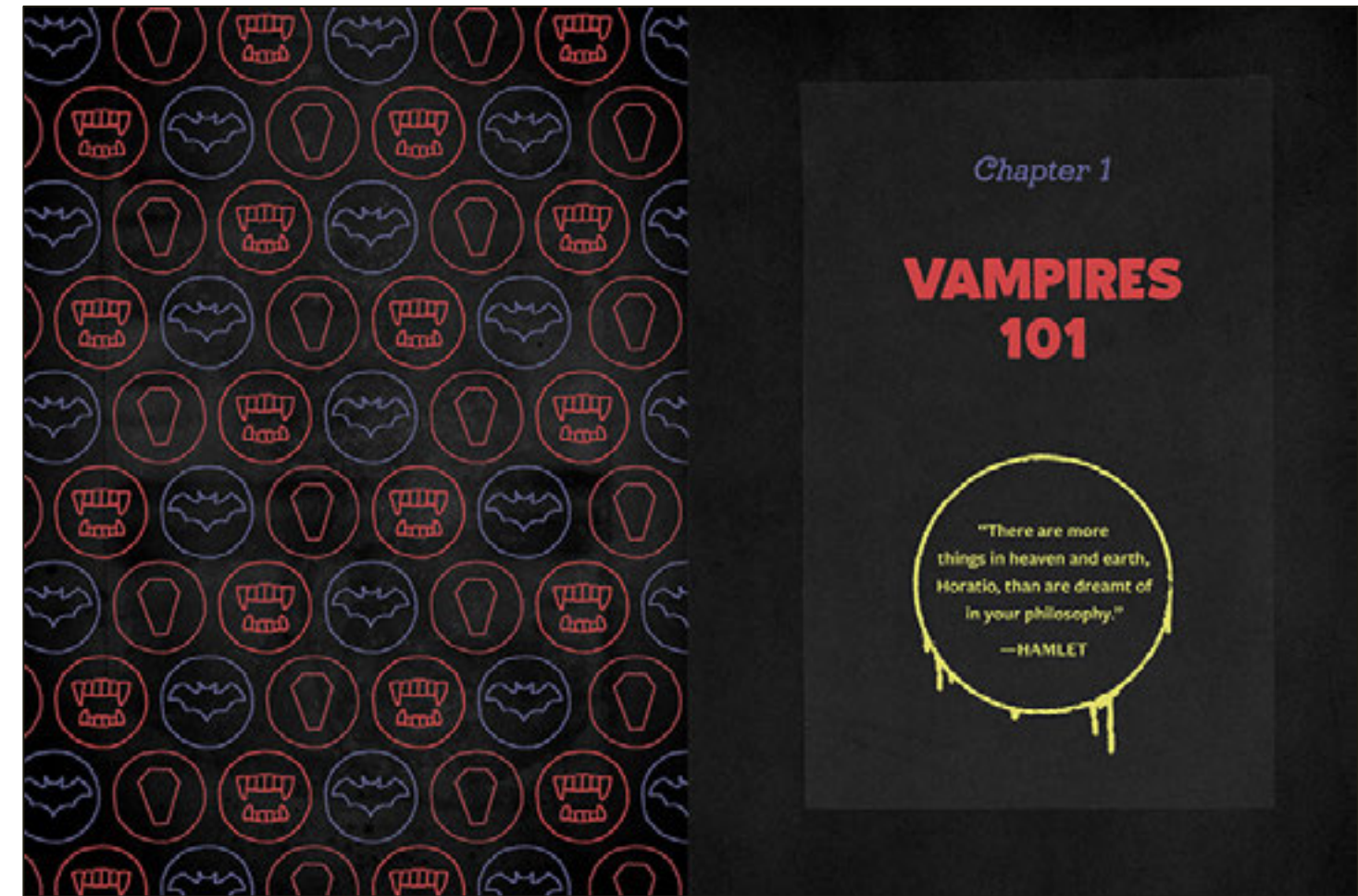

### So You Want to Spot a Vampire

Totally hypothetically speaking, if you met a vampire, do you think you'd be able to tell if they were a vampire? It's not like they walk around holding a sign that says hi, I'm a vampire. Not to worry! Just in case, here's a handy cheat sheet to help you figure out if there is a vampire in your area:

Let's set the scene. A new neighbor just moved into the huge spooky mansion across the street. Strange things have been happening, and you have this feeling that your neighbor is secretly a vampire! Ask yourself . . .

- 1 Are people in your neighborhood starting to act . . . weird?** And I don't mean "weird" as in a quirky personality trait—everyone's different, and that rocks. By "weird," I mean "preyed upon by a vampire." Are people acting like they've been hypnotized? Are turtlenecks and sleepwalking suddenly the latest fashion? Has anyone said to you, "Wow, I met a vampire yesterday, and they totally sucked my blood!" If so, you might have a vampire in your area.
- 2 Are there suddenly a lot of bats in your area?** Your neighborhood might be a hotspot for bats. Three cheers for wildlife! Then again, maybe the bats came with your new vampire neighbor . . .



## Quirk Books, March 2023

- AGE RANGE: 8 to 12
- SPECS: 128 pages, 6" x 8", 4 color
- SUBJECT AREAS:
  - BISAC 1: Juvenile Nonfiction – Paranormal & Supernatural
  - BISAC 2: Juvenile Nonfiction – Folklore & Mythology
  - BISAC 3: Juvenile Nonfiction – History

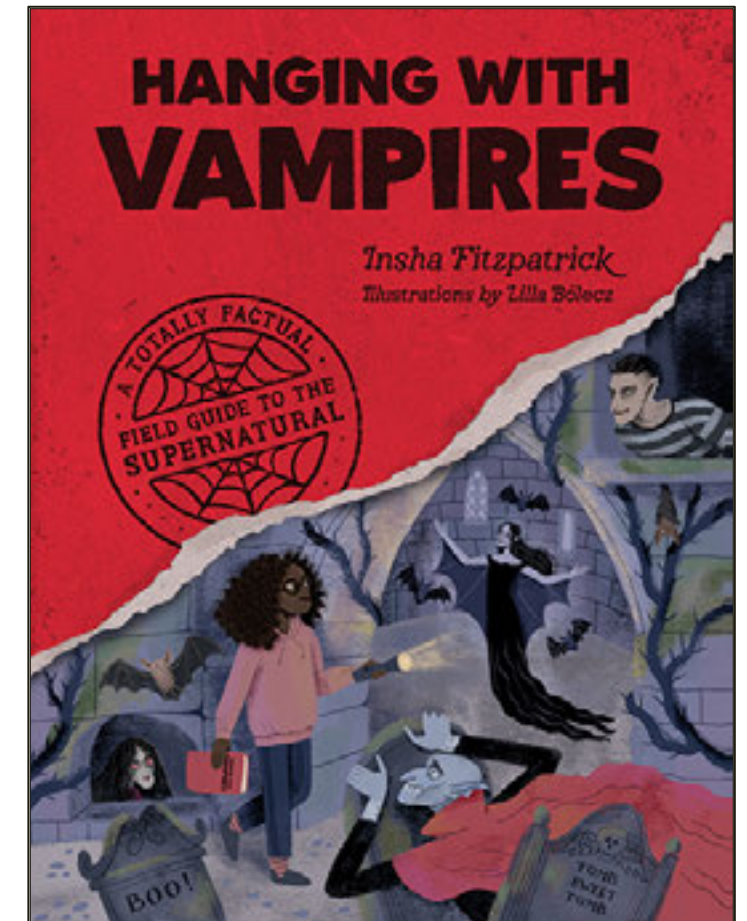

## About the book:

Discover everything about vampires in this laugh-out-loud nonfiction handbook packed with spooky legends, fascinating history, and weird facts perfect for middle-grade readers and mythology fans!

Are vampires real? Who was Vlad the Impaler? Do vampire bats ever feed on humans? Find out in *Hanging With Vampires*, a field guide for the curious and the adventurous. Crack open the lid on this guide to find:

- **Bloodcurdling vampire mythology!** What exactly is a vampire, anyway?
- **Spine-chilling history and science!** Uncover how the vampire legend got its start in the medieval ages.
- **A who's who of vampires!** Get to know classic, iconic, and terrifying vampires in pop culture, from Dracula to *Adventure Time*.

*Hanging With Vampires* is the first book in the Totally Factual Field Guide to the Supernatural series, a hilarious and haunting exploration of how myths and legends shape our lives. Sink your fangs into vampire lore and literature with enchanting illustrations and fun activities, like making garlic bread. It's a spooky world out there—grab your guide, and let's go!

# CHILLING WITH GHOSTS

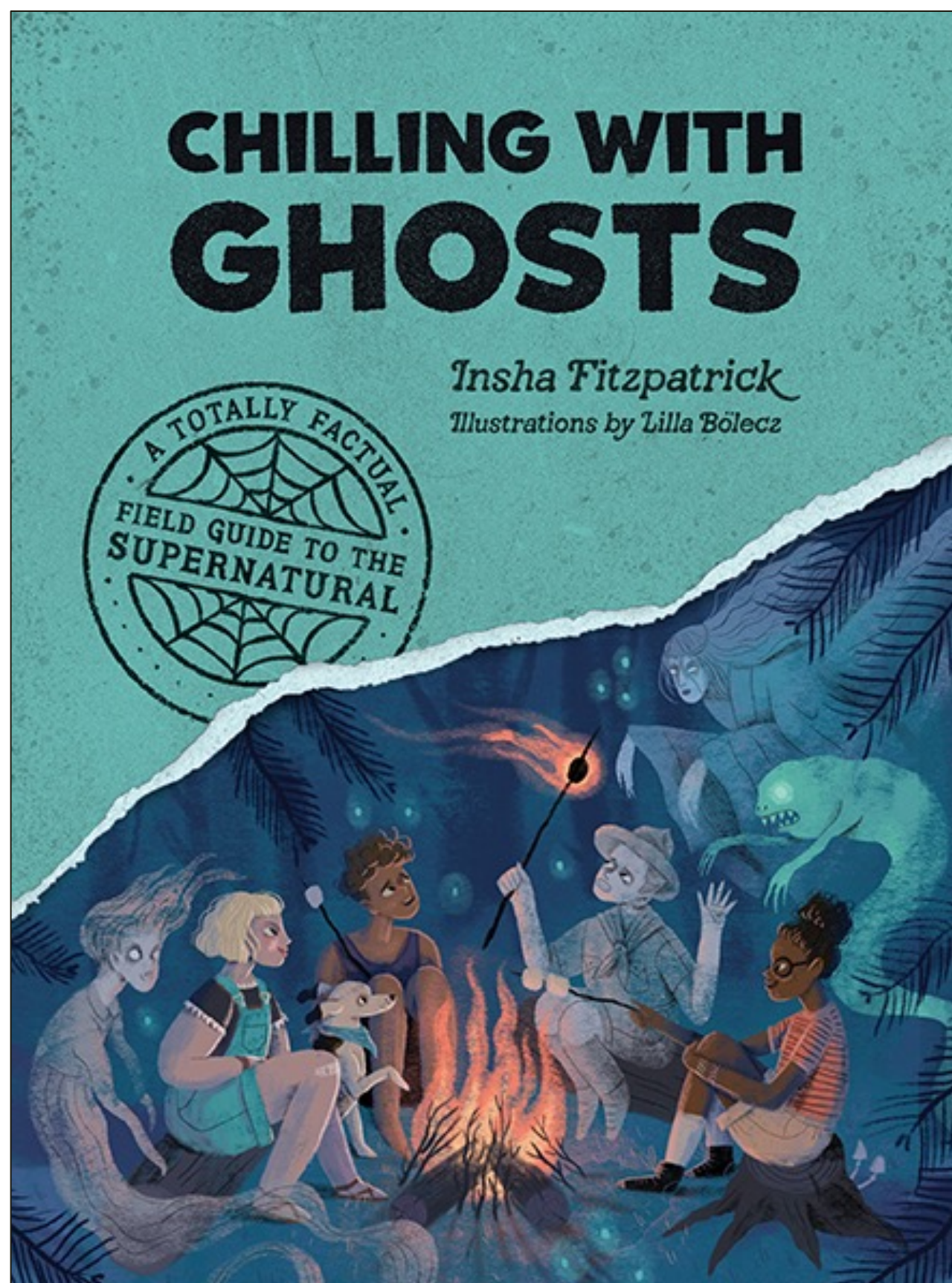

## Chilling With Ghosts

By Insha Fitzpatrick

Illustrated by Lilla Bölec

August 2023

Discover everything about ghosts in this fun handbook packed with spooky tales, engrossing science, and fascinating history—perfect for middle grade readers and mythology fans!

All translation rights available!

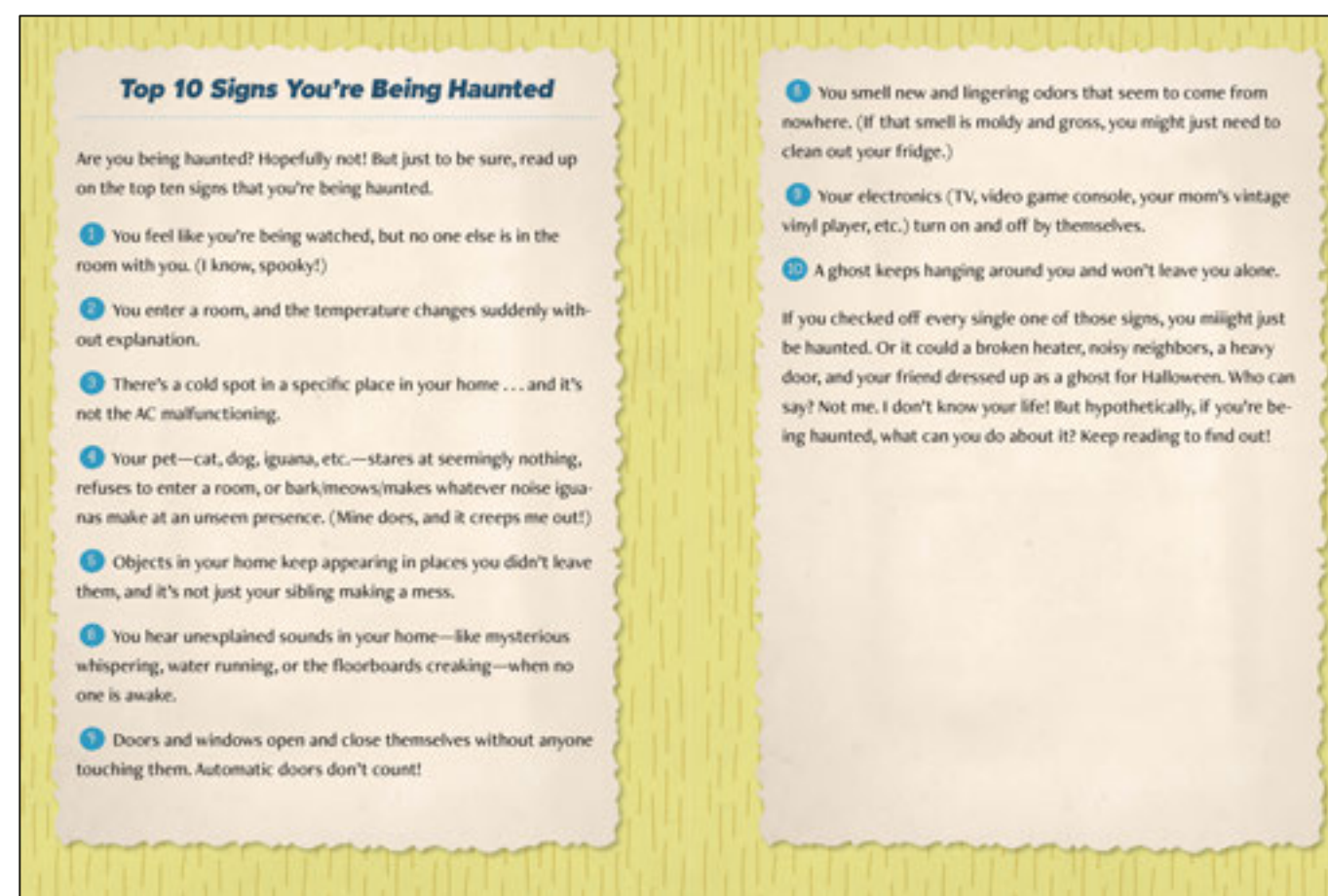

Register your interest and request review materials: [rights@quirkbooks.com](mailto:rights@quirkbooks.com)



CONTENTS		
<b>Introduction</b> <i>Boo! Do you believe in ghosts?</i>		9
<b>Chapter 1: Ghosts 101</b> <i>Hey, what's the deal with ghosts, anyway?</i>		13
<b>Chapter 2: How to Bust a Ghost</b> <i>In case of haunting, open book.</i>		33
<b>Chapter 3: Phantoms of the Past</b> <i>Uncover the spooky history of ghosts. Beware!</i>		55
<b>Chapter 4: Dead Men Tell No Tales</b> <i>Or do they? Read up on ghosts from literature and campfire stories.</i>		73
<b>Chapter 5: Haunted Houses and Spooky Spots</b> <i>Not too scared to explore haunts around the world, are you?</i>		95
<b>Chapter 6: Facing Your Ghosts</b> <i>Facing ghosts and facing fears? Totally not scary. Wink.</i>		109
<b>Conclusion</b> <i>So, do YOU believe in ghosts?</i>		121
<b>Bibliography</b>		126



Welcome to Ghosts 101! On the syllabus we've got all the spectral basics: What makes a ghost a ghost? How do you identify a ghost? What are the different types of ghosts? Where do ghosts like to hang out? Pick up that lantern over there and come with me as we step into the night.

**HOW TO IDENTIFY A GHOST**

When you imagine a ghost, what do you think of? Do you picture someone draped in white bedsheets and two cut-outs for eyes, trick-or-treating on the street? Or do you envision a ghastly apparition dripping with green ectoplasm (a.k.a. a paranormal substance said to allow spirits to materialize)? Maybe you're thinking of a translucent version of a regular person who looks just like you and me.

According to Lisa Morton, author of the book *Ghosts: A Haunted History*, "the shape the undead spirit takes varies according to the particular society's collective imagination." What you think a ghost looks like depends on your context! But in general, Western ghost stories have a few key traits in common. Let's go over these key ghostly characteristics.

**Noncorporeal**

I'm corporeal. You're corporeal—or at least I hope you are! Being corporeal means that you have a physical body. Ghosts are spirits, and they don't have a physical body. That's why in ghost stories, they are often depicted as semitransparent and able to float through walls. For the most part, ghosts can't interact with the physical world. You're not going to catch one scarfing down a bag of chips or playing the piano . . . but of course, there are exceptions. (More on that later!)

**Ye Olde History**

What is a soul? You can define a soul in a variety of ways, and countless philosophers have grappled with this question. Philosophers of the past such as Aristotle, Immanuel Kant, René Descartes, and Plato all have different theories on what a soul is and if souls are even real. A simple definition of the soul is the spiritual essence of a person (or animal) that is a core part of them that sticks around after their physical body dies. Here's one more philosopher for you: Pythagoras. Born in 570 BCE, Pythagoras was a Greek philosopher who believed that when a person dies, their soul leaves their body and jumps into a whole new body. But he wasn't just famous for his theories on the soul. The Pythagorean theorem ( $a^2 + b^2 = c^2$ ) is named after him!

**Haunting Appearance**

Ghosts are generally spooky looking. They might appear as they did when they passed away. Or they might look like whatever appearance captures their essence. They might not even look like a human—they might resemble a see-through zombie or a ball of light!

**Ability to Float or Fly**

Given that ghosts are noncorporeal, gravity doesn't exactly apply to them. In most tales, ghosts can walk through walls, float above the ground, and even fly.



## Quirk Books, August 2023

- AGE RANGE: 8 to 12
- SPECS: 128 pages, 6" x 8", 4 color
- SUBJECT AREAS:
  - BISAC 1: Juvenile Nonfiction – Paranormal & Supernatural
  - BISAC 2: Juvenile Nonfiction – Folklore & Mythology
  - BISAC 3: Juvenile Nonfiction – History

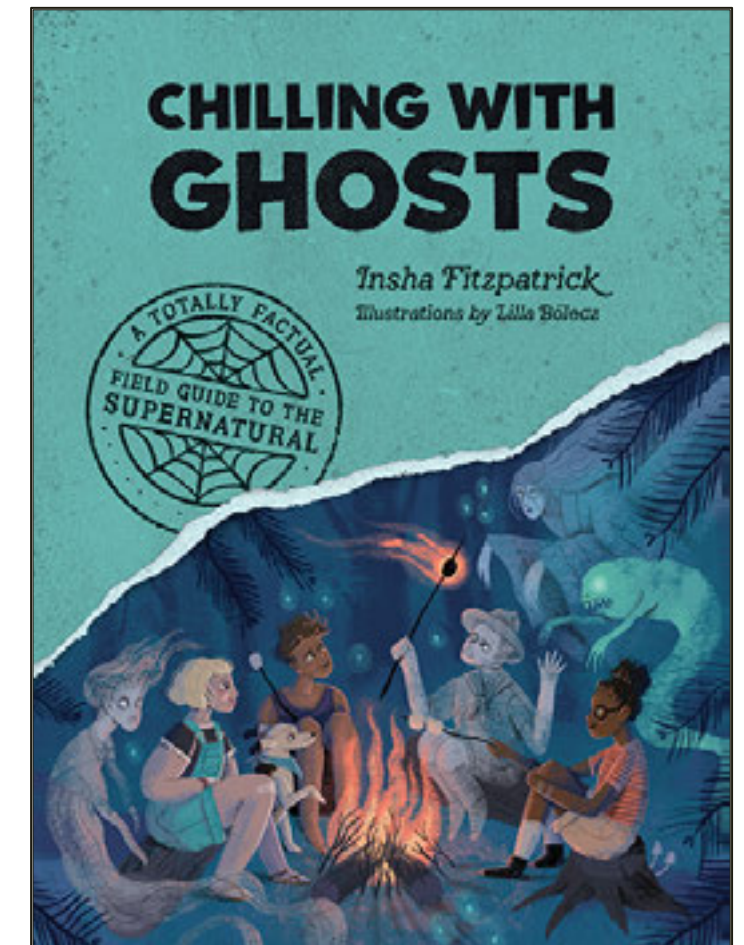

## About the book:

Discover everything about ghosts in this fun handbook packed with spooky tales, engrossing science, and fascinating history—perfect for middle grade readers and mythology fans!

Boo! Do you believe in ghosts? What's up with haunted houses? And how exactly do you bust a ghost? Uncover the spooky and spectacular world of ghosts in *Chilling With Ghosts*, a field guide for the curious and the adventurous. Step into the unknown—if you dare!—and discover:

- **Scary ghost stories of all kinds!** Learn how to tell your very own ghost story.
- **Terrifying tales from history and weird science!** Find out what ghost fungus is and meet a couple of Shakespearean ghosts.
- **A globe-trotting tour of haunted spots!** Travel all around the world, from the Catacombs of Paris to the Stanley Hotel.

*Chilling With Ghosts* is the second book in the Totally Factual Field Guide to the Supernatural series, a hilarious and haunting exploration of how myths and legends shape our lives. Get to know ghost lore with enchanting illustrations and hands-on activities, like brewing homemade ectoslime. It's a spooky world out there—grab your guide, and let's go!

# PET THAT DOG

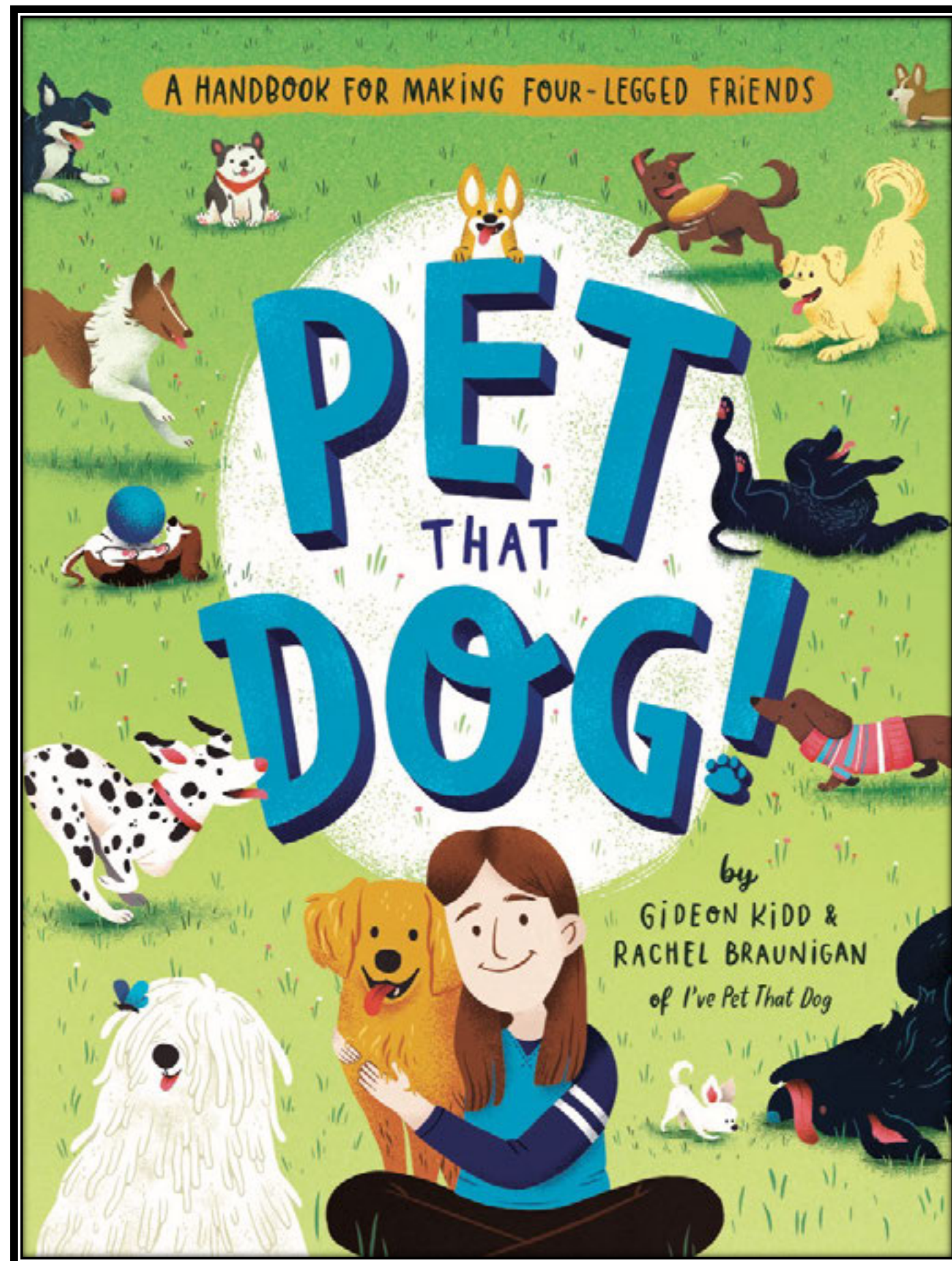

*Pet That Dog! A Handbook for Making Four-Legged Friends* is a highly-illustrated guide to meeting, caring for, and learning about humans' best friend.

## TARGET CONSUMER:

- Children ages 7 and up (particularly ages 7-10)
- Dog lovers
- Parents and gift givers
- Kids who are curious about dogs but feel a little unsure around them

Rights Sold: Hungarian (Kossuth)

### Introduction: I've Pet That Dog!

My name is Gideon and I love dogs. So far, I have petted more than one thousand different dogs. I've always asked to pet every dog I see. I know all the dogs in my neighborhood and many of the dogs in my town. I think dogs are amazing creatures. I love that each one looks different and has a different story. My favorite dogs are the biggest dogs and the smallest dogs. I like everything about dogs.

When I was eight years old, I decided to keep track of each dog I met. I asked my mom if I could take a picture with each dog I petted to show everyone. At first she was confused, but then she said that I could start a website. On my site, I put a picture of myself with each dog I meet. I also keep a count of how many different dogs I've met.

Most of the time, when I meet dogs people tell me stories about them. When I joined Twitter in 2018, I decided to share these stories along with the pictures. Each dog I meet teaches me something new. I find dogs everywhere I go. Some are big, some are tiny. Some dogs have jobs. Some are playful. Some are fearful. Some dogs have homes and families. Some dogs are looking for a home. Each dog is different, and each dog has a story.





## Introduction: I've Pet That Dog!

My name is Gideon and I love dogs. So far, I have petted more than one thousand different dogs. I've always asked to pet every dog I see. I know all the dogs in my neighborhood and many of the dogs in my town. I think dogs are amazing creatures. I love that each one looks different and has a different story. My favorite dogs are the biggest dogs and the smallest dogs. I like everything about dogs.

When I was eight years old, I decided to keep track of each dog I met. I asked my mom if I could take a picture with each dog I petted to show everyone. At first she was confused, but then she said that I could start a website. On my site, I put a picture of myself with each dog I meet. I also keep a count of how many different dogs I've met.

Most of the time, when I meet dogs people tell me stories about them. When I joined Twitter in 2018, I decided to share these stories along with the pictures. Each dog I meet teaches me something new. I find dogs everywhere I go. Some are big, some are tiny. Some dogs have jobs. Some are playful. Some are fearful. Some dogs have homes and families. Some dogs are looking for a home. Each dog is different, and each dog has a story.



**8-14:** You are a **Chihuahua!** You are very loyal to the people in your life. Your friends and family are everything to you. You like to be included in the fun and get sad if you are alone too much.



**15-20:** You are a **Pomeranian!** There is nothing shy about you. You enjoy looking your best and staying active. You love to talk and will share your opinions with everyone.



**21-27:** You are a **Pug!** You are the clown in your family. You make everyone laugh. Sleep and food are very important to you. You'll never turn down a tasty treat or a nap on the couch.

Every dog looks different, has a different personality, and lives a different life. Every dog has their own story. When I want to get to know a dog, I ask questions. Most people like to talk about their dog and will be willing to answer your questions.

## I ASK:

- CAN** I pet your dog? toys?
- WHAT** is your dog's name? **WHAT** is his favorite food?
- WHAT** kind of dog is he? **DO** you have any funny stories about your dog?
- WHERE** did you get your dog? **WHAT** was your dog's biggest adventure?
- WHAT** do you like about your dog? **WHAT** does your dog like to do?
- WHAT** is unique about him?
- DOES** he like to play with



When a dog is relaxed, with her mouth open and tongue out, she is happy and comfortable.

When a dog wants to play, his body is loose and wiggly. He lowers the front of his body into a play bow. Your dog might do this when he wants you to throw the ball.



If a dog looks like she is frozen and not moving, it is because she is unsure or uncomfortable.

Many people think that dogs are tired when they yawn. Instead, yawning is how dogs showing that they are nervous.

When a dog cowers or lowers their body to the ground with his ears back, he is afraid.

Another way dogs show their fear is by tucking their tails under their body.

A scared dog may pant very fast.

When a dog's fur stands up on her shoulders, spine, or tail, it is called *hackles*. This does not mean that she is about to attack. It means she is upset, nervous, and excited about something. When you see *hackles* go up on a dog, back away and give her space so that she can feel comfortable.



Each dog is unique. I keep track of the dogs I meet by taking a picture with them. I like to see how many different breeds I can meet. It's also fun to see how many unique dogs I can find. How many of these different dogs can you meet?

- Shaggy dog**  
NAME: \_\_\_\_\_ DATE: \_\_\_\_\_  
NOTES: \_\_\_\_\_
- Spotted dog**  
NAME: \_\_\_\_\_ DATE: \_\_\_\_\_  
NOTES: \_\_\_\_\_
- Large dog**  
NAME: \_\_\_\_\_ DATE: \_\_\_\_\_  
NOTES: \_\_\_\_\_
- Tiny dog**  
NAME: \_\_\_\_\_ DATE: \_\_\_\_\_  
NOTES: \_\_\_\_\_
- Brindle dog**  
NAME: \_\_\_\_\_ DATE: \_\_\_\_\_  
NOTES: \_\_\_\_\_

Many towns also have dog-friendly events, such as howl-oween pet parades, pet pictures with Santa, dog fests, and dog competitions. By doing research online, in your local paper, or even on social media, you can find out about dog-friendly events near you.



### Tip from Gideon:

If you want a specific breed of dog, but also want to adopt, there are ways to do it! Talk to your local shelter or rescue and let them know what kind of dog you are looking for. Make sure you fill out an application and are approved so when the dog you want is available, you can be first on the list! Don't forget to check your state for breed-specific rescues. Working with a rescue can help many dogs and also help you learn more about your favorite breed. Lastly, don't ignore mixes. These shelter specials may not be purebred, but they can be awesome, loving dogs! A Pug Pug mix can give you all the personality of their breed, and by adopting them, you save a dog who needs a home.



## Quirk Books, October 2020

- AGE RANGE: 7 to 10
- SPECS: 128 pages, 6" x 8", 4 color
- SUBJECT AREAS:
  - BISAC 1: Juvenile Nonfiction – Animals - Dogs
  - BISAC 2: Juvenile Nonfiction – Social Topics – New Experience
  - BISAC 3: Juvenile Nonfiction – Activity Books

### About the book:

From 11-year-old dog-loving Gideon Kidd of the popular Twitter account *I've Pet That Dog* comes a guide for young readers to befriend and care for dogs of all shapes, sizes, and personalities!

*Pet That Dog! A Handbook for Making Four-Legged Friends* is an illustrated guide to meeting, petting, and caring for dogs by Gideon and his mom, Rachel Braunigan. Learn how dogs communicate through body language, helpful tips for safely interacting with dogs, and fun facts about dogs to share with friends. (Did you know that all-white dogs are more likely to be deaf? Or that dogs poop in alignment with the north-south axis of the Earth's magnetic field?) You can even keep track of the pups you meet with your very own Dog Tracker.

With an interactive format and joyful illustrations of lovable dogs, *Pet That Dog!* makes a perfect gift for dog lovers and dog-curious kids.



# PET THAT CAT!



## Pet That Cat!

By Nigel Kidd & Rachel Braunigan

Illustrated by Susann Hoffmann

July 2022

A feline follow-up to *Pet That Dog!*, featuring heartwarming stories of cats, advice for adopting and taking care of your own cat, a guide to cat body language, myth-busting facts about cats, a "cats I've met" tracker, and more.

Rights Sold: Czech (Albatros)

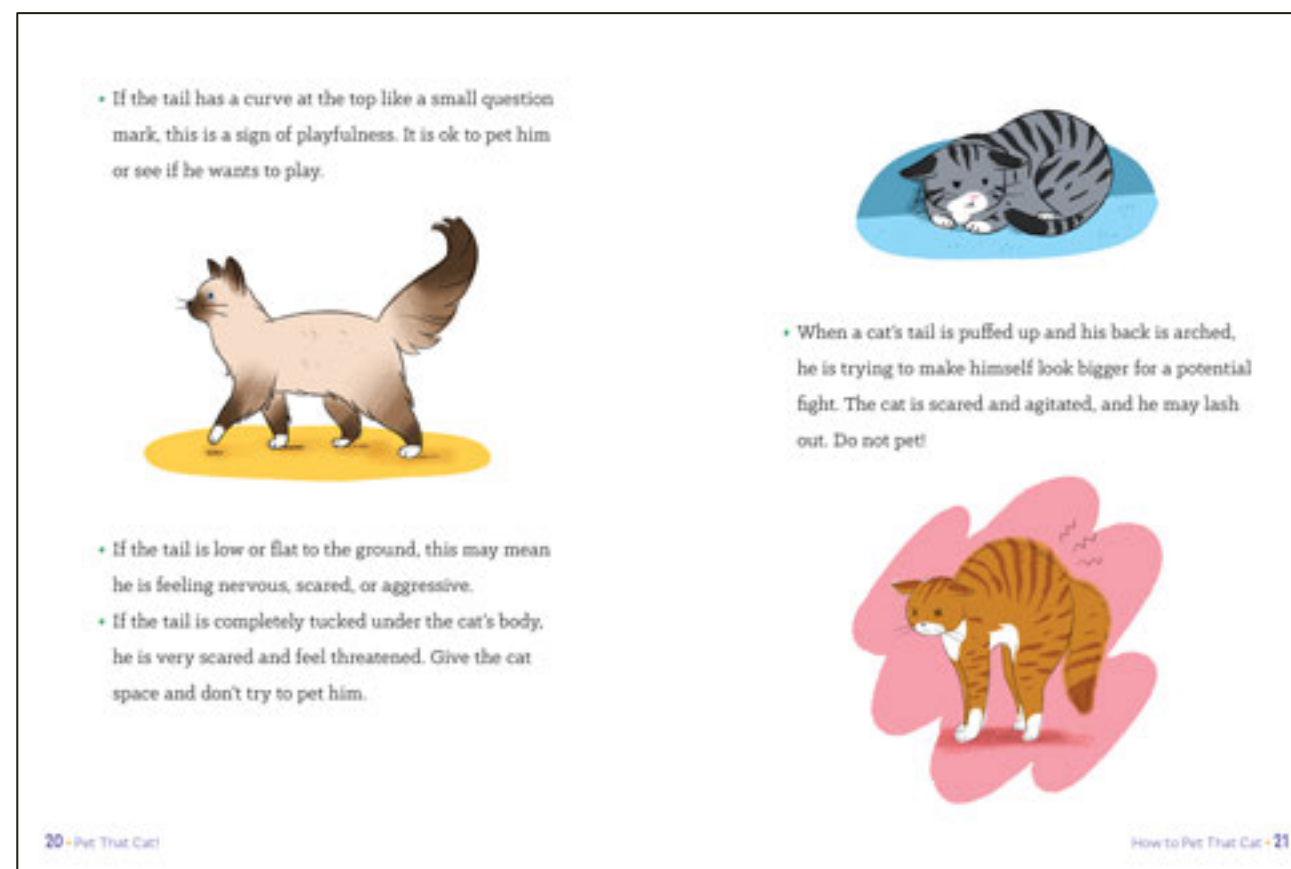

Register your interest and request review materials: [rights@quirkbooks.com](mailto:rights@quirkbooks.com)

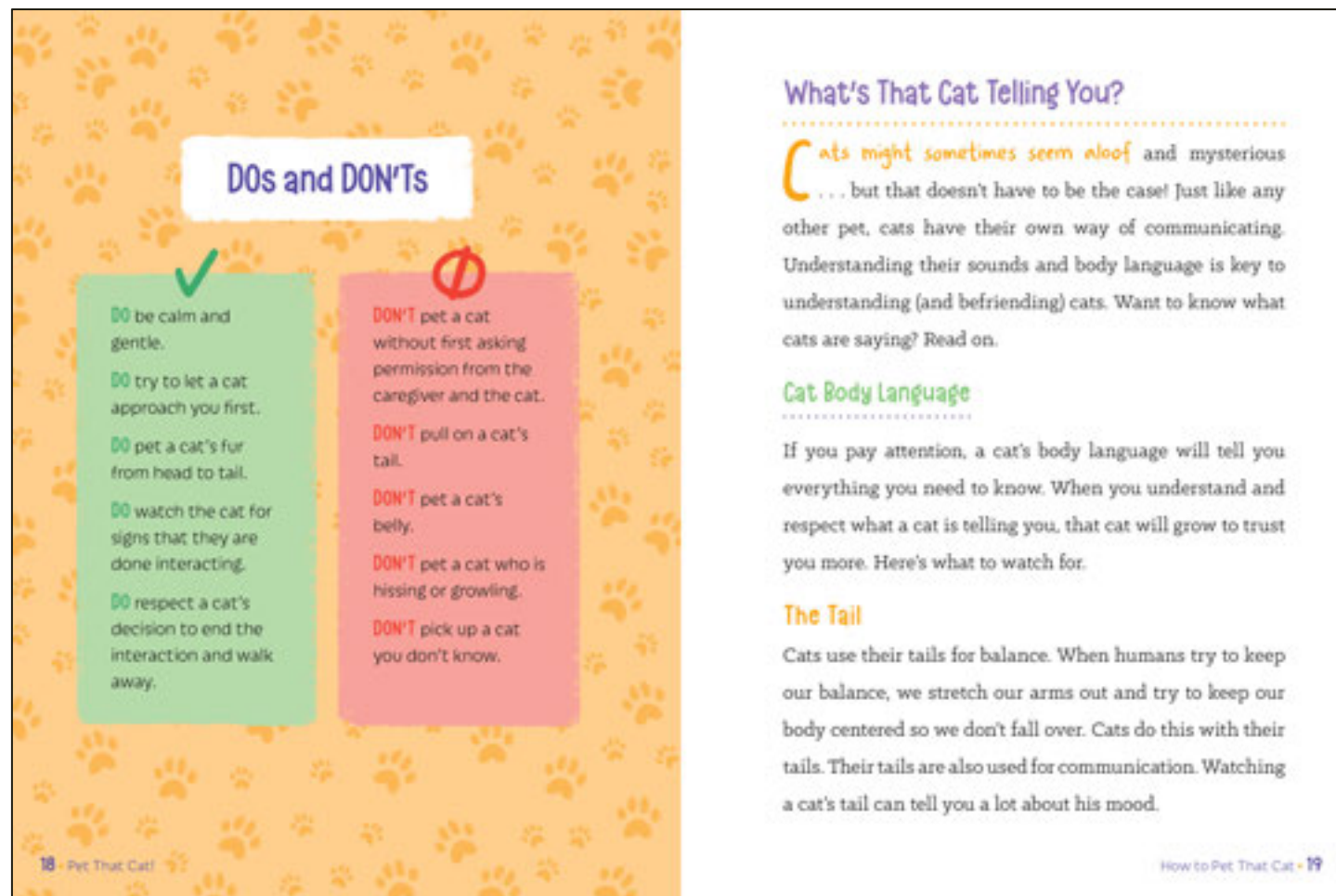

## What's That Cat Telling You?

Cats might sometimes seem aloof and mysterious... but that doesn't have to be the case! Just like any other pet, cats have their own way of communicating. Understanding their sounds and body language is key to understanding (and befriending) cats. Want to know what cats are saying? Read on.

### Cat Body Language

If you pay attention, a cat's body language will tell you everything you need to know. When you understand and respect what a cat is telling you, that cat will grow to trust you more. Here's what to watch for.

#### The Tail

Cats use their tails for balance. When humans try to keep our balance, we stretch our arms out and try to keep our body centered so we don't fall over. Cats do this with their tails. Their tails are also used for communication. Watching a cat's tail can tell you a lot about his mood.

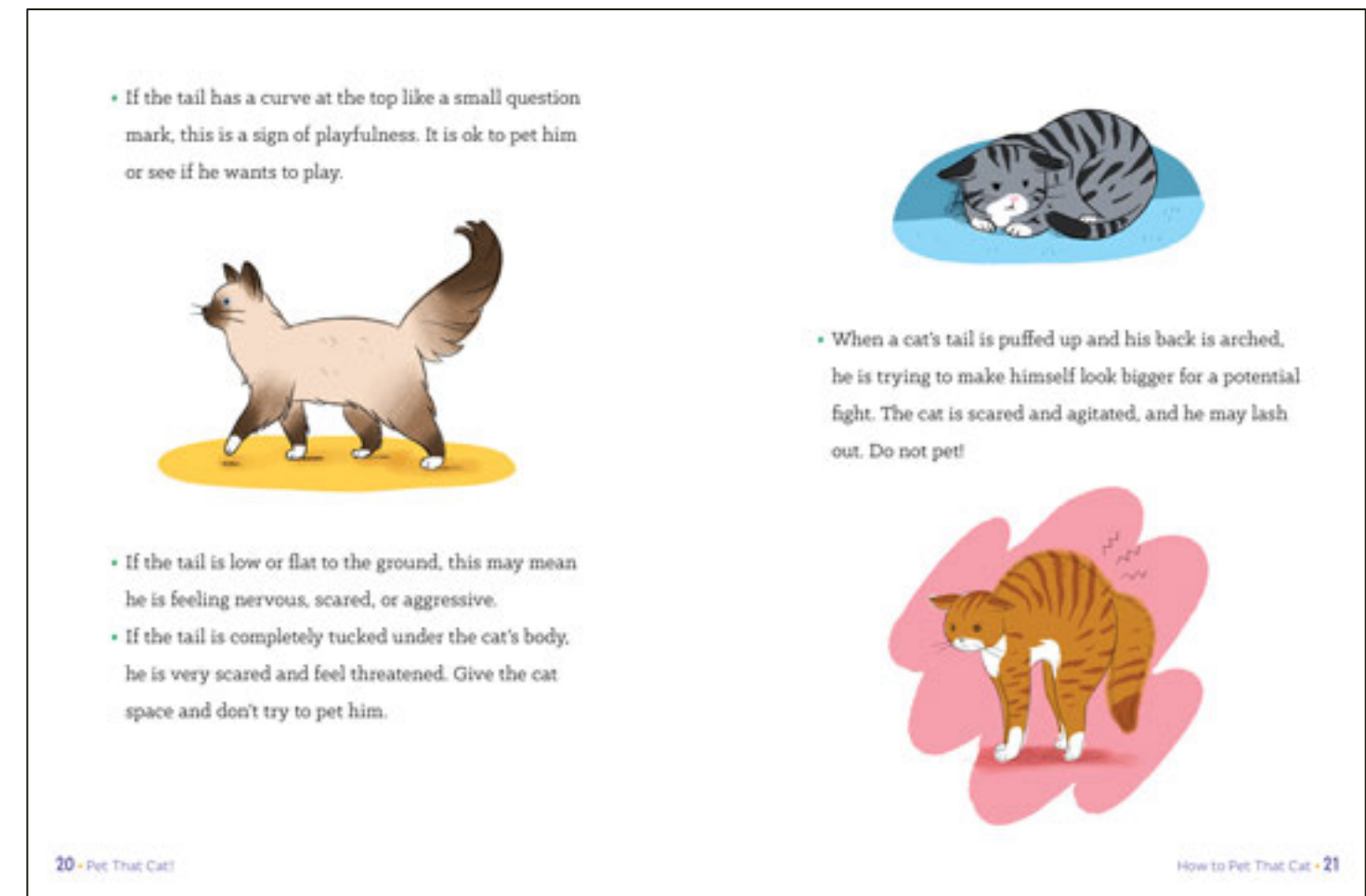



## Quirk Books, July 2022

- AGE RANGE: 7 to 10
- SPECS: 128 pages, 6" x 8", 4 color
- SUBJECT AREAS:
  - BISAC 1: Juvenile Nonfiction – Animals - Cats
  - BISAC 2: Juvenile Nonfiction – Social Topics – New Experience
  - BISAC 3: Juvenile Nonfiction – Activity Books

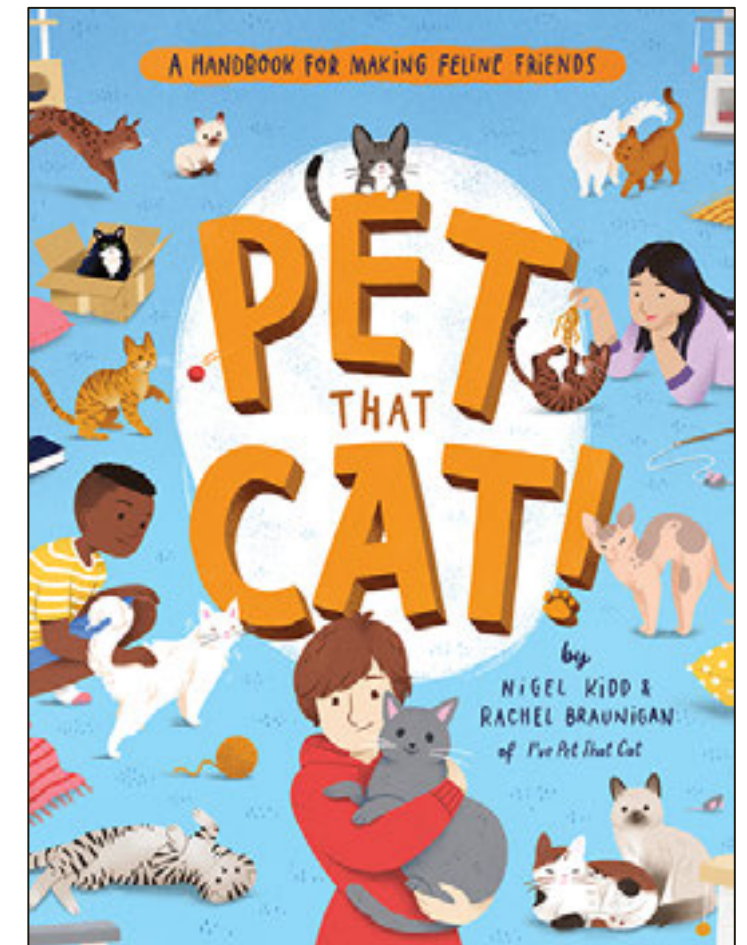

## About the book:

A fun and informative handbook for young readers on understanding and caring for our feline friends from the kid behind the popular Twitter account *I've Pet That Cat!*

*Pet That Cat! A Handbook for Making Feline Friends* is an illustrated guide to understanding, befriending, and caring for cats by Nigel Kidd and his mom, Rachel Braunigan.

This fact-filled and fun guide features:

- A guide to cat body language—what does it mean when your cat's tail looks like a question mark or is puffed up?
- Helpful tips on how to safely interact with new feline friends. Hint: Let them approach first!
- Advice for adopting and caring for your own cat. Choose the perfect cat for you!
- Stories of cats throughout history and myth-busting facts—did you know every cat has a unique noseprint?
- A cat personality quiz and your very own Cat Tracker to record all the feline friends you meet!

This kid-friendly handbook pairs charming illustrations with an interactive format. With step-by-step guides, fascinating stories, and tips from cat experts and Nigel, *Pet That Cat!* is a must-have handbook for feline fans of all ages.

# KID OLYMPIANS



Inspiring, relatable, and totally true biographies tell the childhood stories of a diverse group of international athletes who have captured the world's attention at the Summer Olympics.

## TARGET CONSUMER:

- Children 8-12 with an interest in sports
- Readers of KID LEGENDS series
- Teachers, librarians, and parents

Rights Sold: All world rights available.

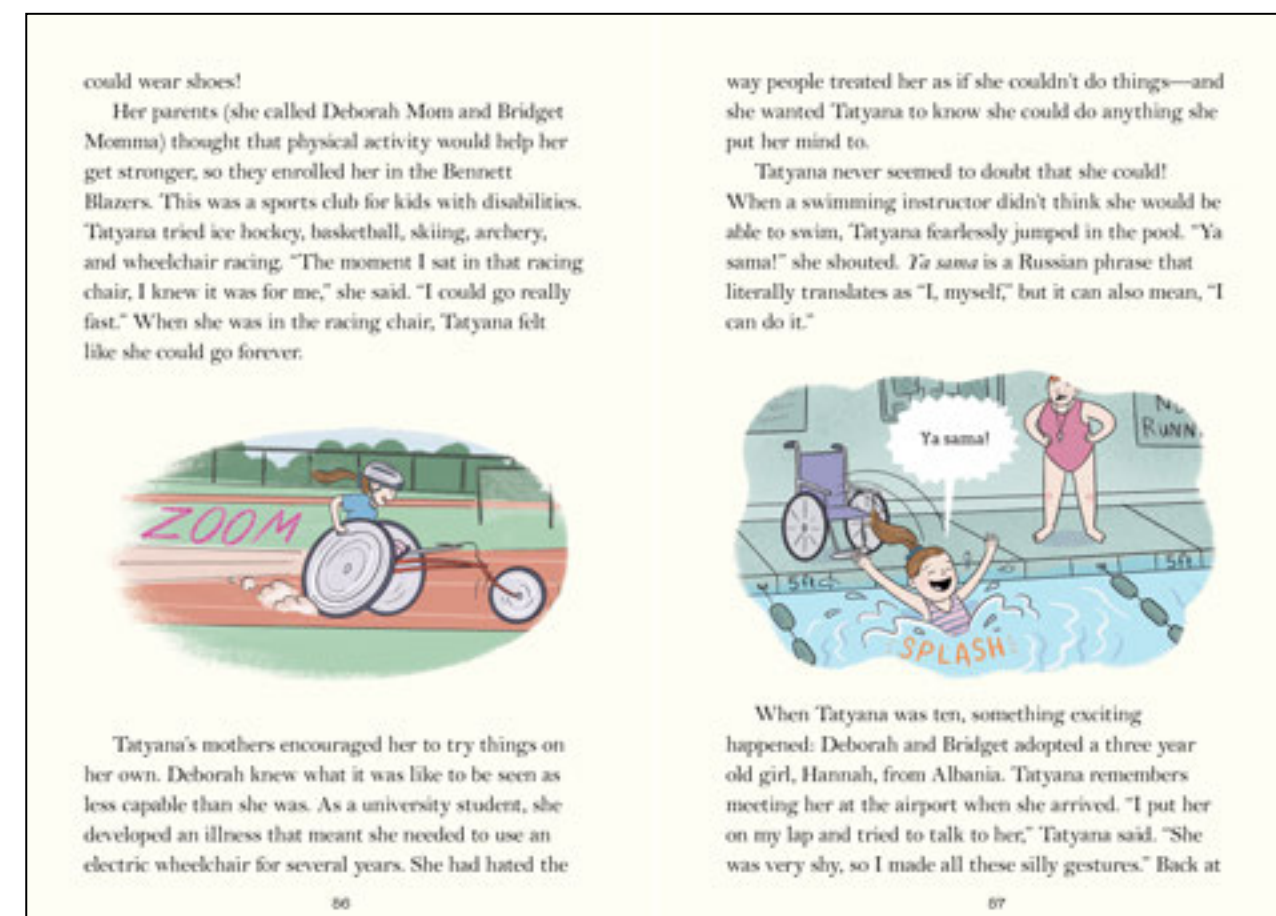

To register interest: [rights@quirkbooks.com](mailto:rights@quirkbooks.com)



## Quirk Books, August 2022

- AGE RANGE: 8 to 12
- SPECS: 224 pages, 5-1/2" x 8", 4 color
- SUBJECT AREAS:
  - BISAC 1: Juvenile Nonfiction – Biography – Science & Technology
  - BISAC 2: Juvenile Nonfiction – People and Places
  - BISAC 3: Juvenile Nonfiction – Inventions

### About the book:

Inspiring, relatable,, and totally true childhood biographies of Simone Biles, Jesse Owens, Michael Phelps, Serena Williams, Tatyana McFadden, and more.

Exceptional athletes throughout history have dreamed of competing in the Olympics—and some were kids themselves when those dreams and plans began! In *Kid Athletes: Summer Olympians*, discover the childhood stories of legends like **Usain Bolt**, the fastest man in the world, who used to skip after-school practices to play video games. **Serena Williams** sometimes hit her tennis ball over the fence on purpose so she'd have an excuse to take a break! Gymnast **Nadia Comaneci**'s mother signed her up for gymnastics at five, to give her an outlet for her endless energy. Running star **Wilma Rudolph** survived polio and had to learn to walk again before she could run.

Featuring kid-friendly text and full-color illustrations, readers will learn about the young lives of people like **Dick Fosbury**, **Ibtihaj Muhammad**, **Gertrude Ederle**, **Yusra Mardini**, **Ellie Simmonds**, **Tommie Smith**, **Megan Rapinoe**, and **Naomi Osaka**.

#9 in the [Kid Legends series](#).



## About the KID LEGENDS series

Before they were famous, they were kids, struggling with regular-kid problems like bullies, homework, and arguments with their siblings.

Inspiring anecdotes and playful illustrations reveal the relatable childhood escapades of celebrated presidents, great athletes, groundbreaking scientists, and other future legends.





## Praise for the series:

“Telling the true stories of famous people’s childhoods, this book inspires kids to think big and humanizes historical figures in a new and fresh way.”—*CNN Underscored*, on *Kid Innovators* by Robin Stevenson

“These reads aren’t just educational, they’re inspiring – they remind us all that we’re never too young to start dreaming! Plus – they’re a great resource for school projects!”—*YAYOMG.com*, on *Kid Innovators* by Robin Stevenson

“Kids will be drawn in.”—*Chicago Parent*, on *Kid Activists* by Robin Stevenson

“The vivid details of each activist's story, combined with vibrant illustrations, demonstrate that every civil rights hero and popular firebrand started out as children, just like the rest of us.”—*School Library Journal*, on *Kid Activists* by Robin Stevenson

“A great way to encourage kids who already love science to pursue their interests as well as to show kids who are not motivated by traditional schooling that there are many paths to greatness.”—*American Scientist Magazine*, on *Kid Scientists* by David Stabler

“Illustrate[s] a wide variety of early influences and backgrounds, proving to kids that where they come from isn't important when fixing something that is.”—Terri Schlichenmeyer, *The Bookworm Sez*, on *Kid Activists* by Robin Stevenson

“Outstanding... Inspiring and entertaining.”—*Booklist*, starred review, on *Kid Athletes* by David Stabler

“A heartening reminder that 17 unconventional greats—not to mention all the rest—started out as children too.”—*Kirkus Reviews*, on *Kid Artists* by David Stabler

“Just like history class, only hilarious.”—Tim Federle, author of *Better Nate Than Ever*, on *Kid Presidents* by David Stabler

“Full of real information, but the author made it fun and funny.”—Michael, age 9, on *Kid Authors* by David Stabler

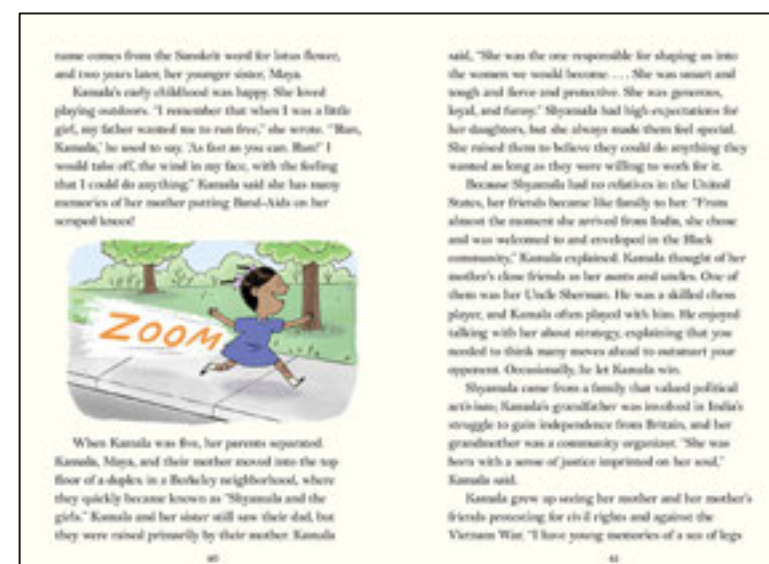
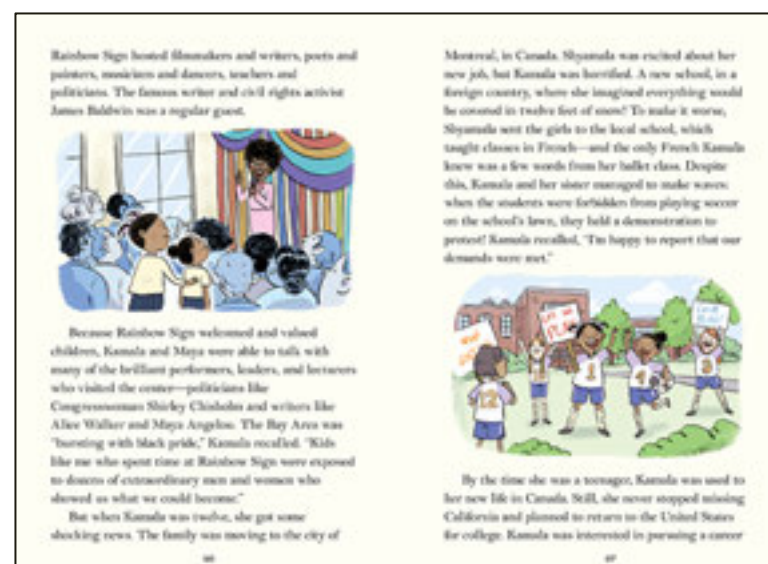

# THE WILD WORLD HANDBOOK SERIES

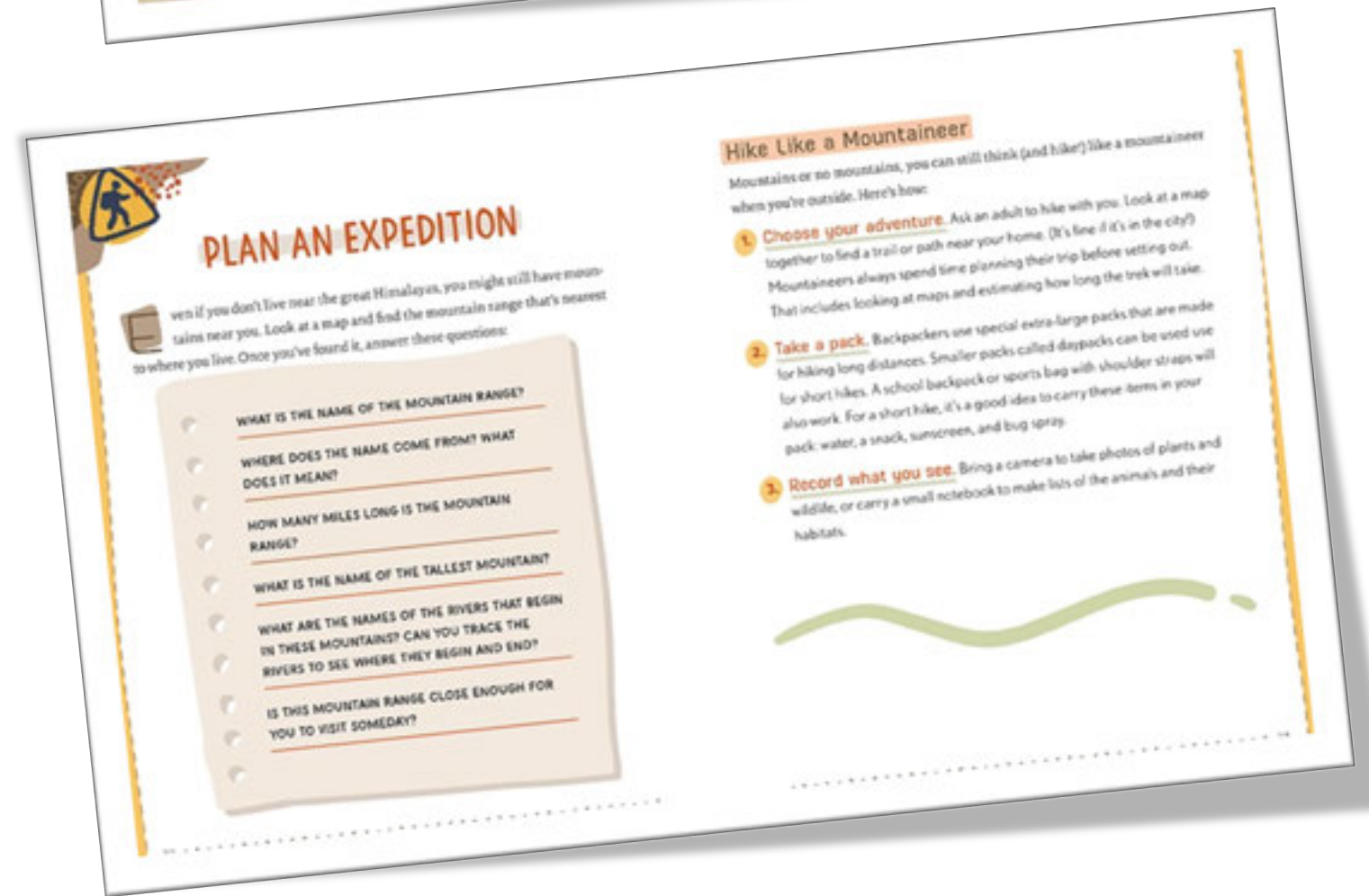
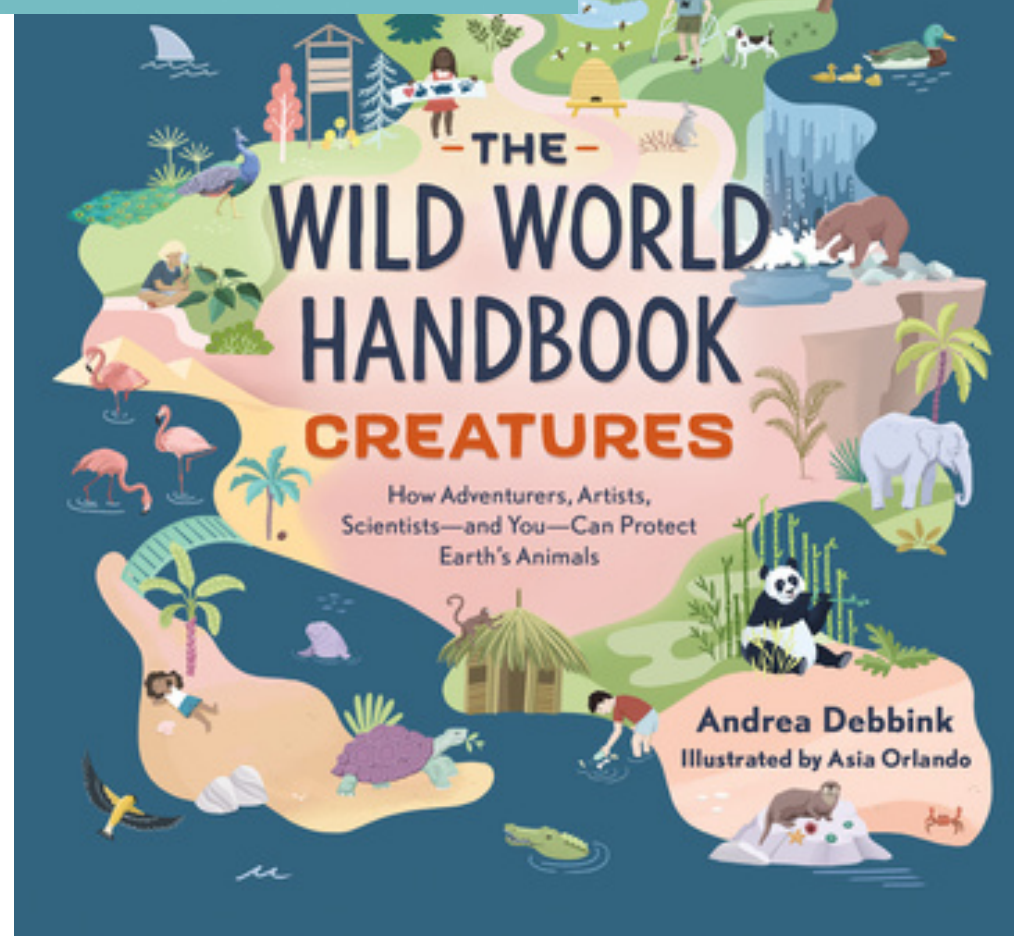
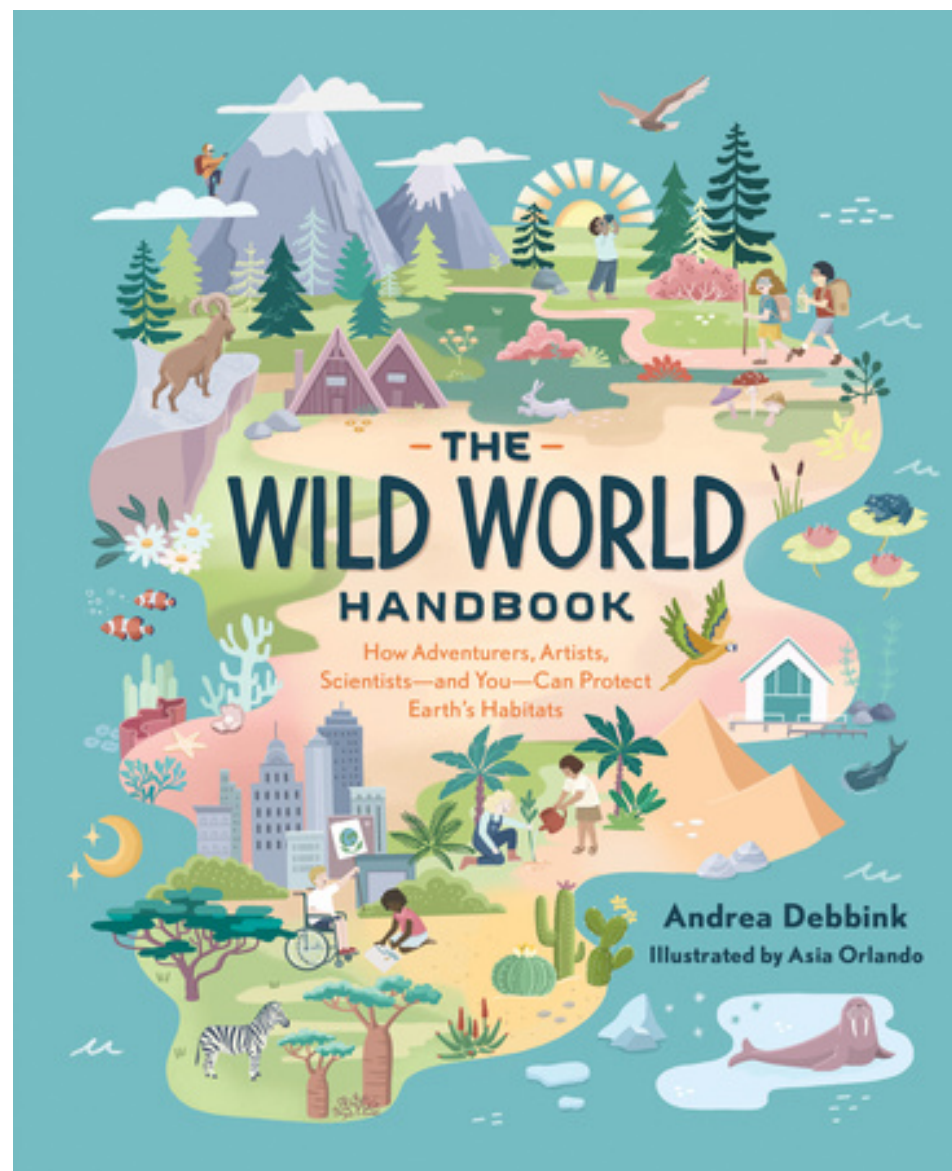



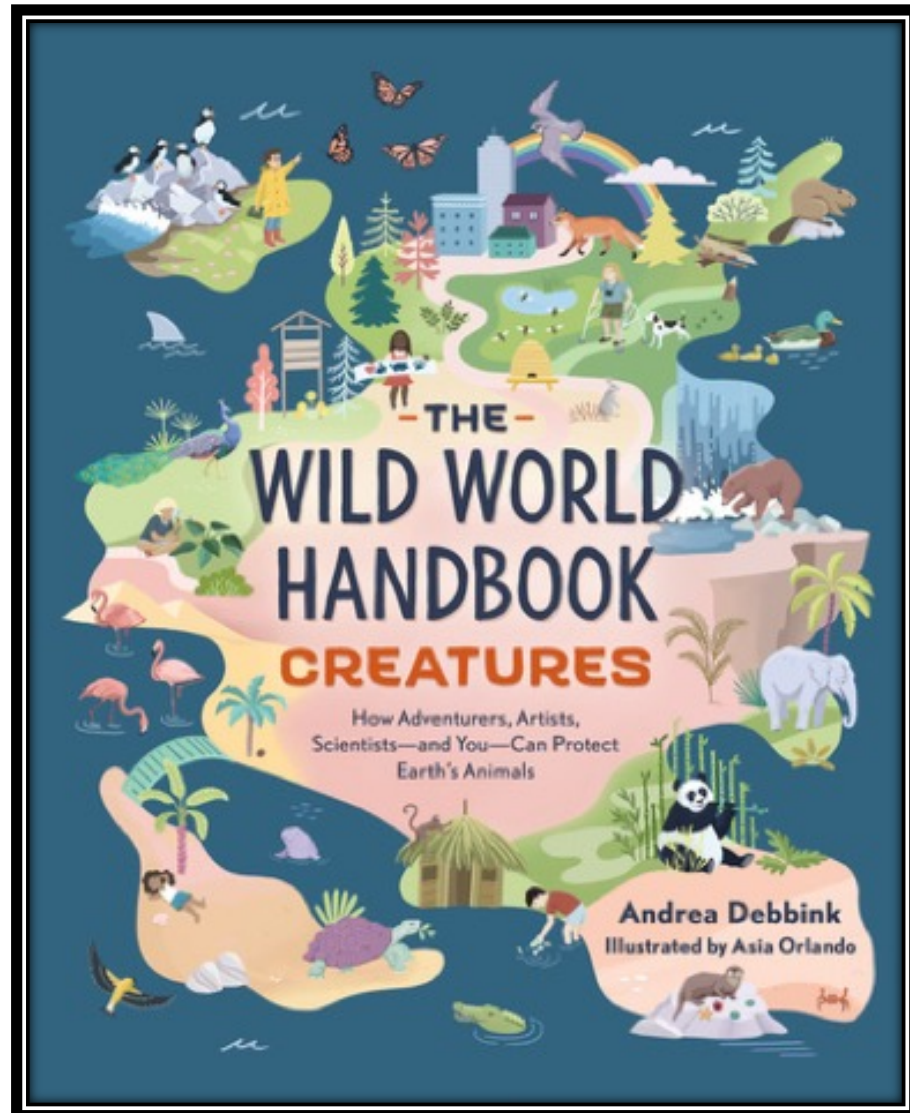

## PRAISE FOR THE SERIES:

### Praise for *The Wild World Handbook: Creatures*

"Hooks readers from the beginning...A treasure trove of animals, familiar as well as not so well-known, and the scientists and activists who help them survive and thrive."—*School Library Journal*, **starred review**

"Animals are always a hot topic for kids, and this STEAM offering for middle-graders is **sure to please.**"—*Booklist*

"Filled with history and facts about creatures that are **beautifully expressed and explained.**"—*Beary Into Books*

"A wonderful book packed with **amazing information!**"—*The Momma Spot*

"A must have for families looking to make a difference in the world...Get ready to be blown away with the awe inspiring illustrations that fill the pages of this environmental stewardship handbook, while gaining practical tools and skills."—*Inspired by Savannah*

### Praise for *The Wild World Handbook: Habitats*

PureWow Happy Kid Award Winner 2021 for Best 8+ Book

"This **gorgeous** book features beautifully detailed illustrations, facts, stories and tips on making your own biome and helping to protect the environment.... A **practical guide for young climate activists and junior conservationists.**"—*CNN Underscored*

"**Beautifully illustrated....An entertaining and educational** book for environmentally conscious nature lovers that **will inspire action.**"—*Booklist*

"**Well-designed and smartly organized...**providing inspiration that proves that all types of people can enjoy and protect nature."—*Kirkus Reviews*

"This **accessible** guide offers a good balance of detailed information with **engaging activities** and calls to action....A strong choice to inspire young changemakers for our planet."—*School Library Journal*

"**Hopeful**, even as it leaves no stone unturned on the path to mitigating grave ecological issues like climate change, deforestation and overfishing...The result leaves readers — whether middle grade or middle-aged — informed, inspired and, most importantly, empowered."—*Madison Magazine*

"For the quieter kid, or perhaps for an Earth-minded child who may need to stay indoors for part of the summer...With more facts, less adventure, this book offers ecology-based biographies, activities to do indoors, fun facts, places to visit, and information about our world."—Terri Schlichenmeyer

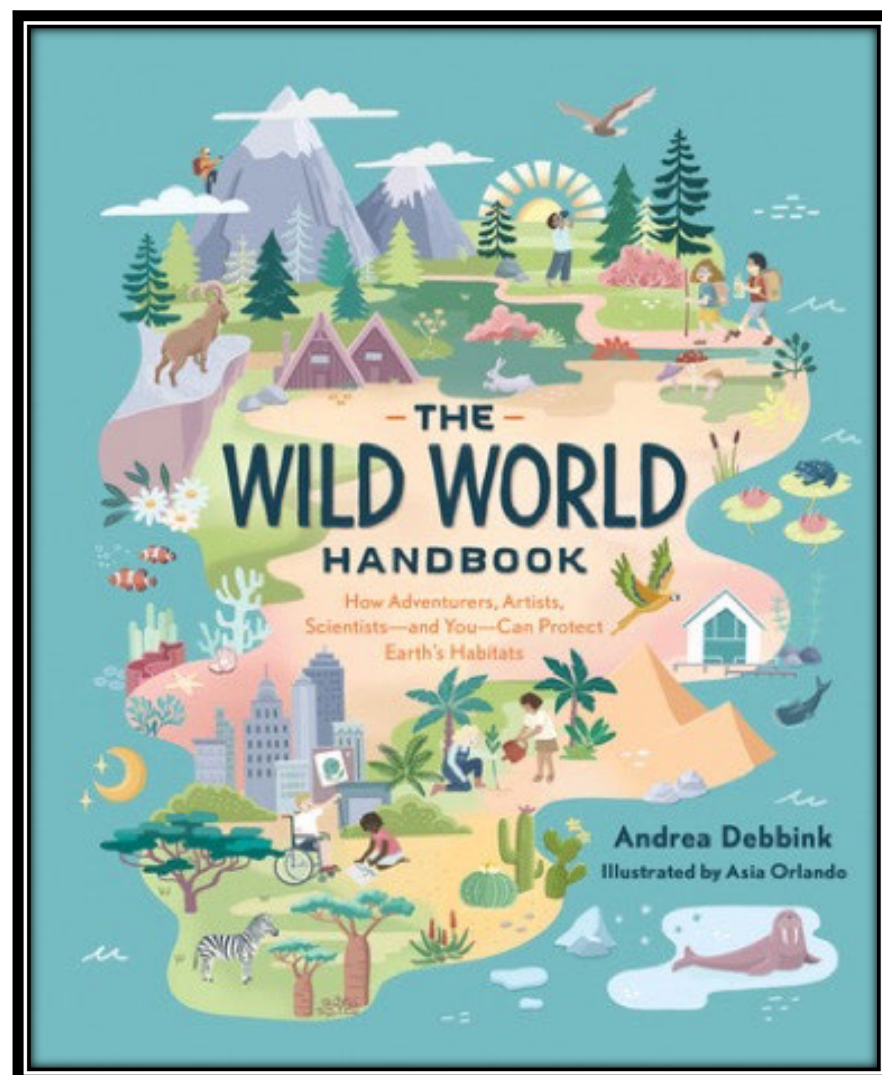

# WILD WORLD HANDBOOK: HABITATS

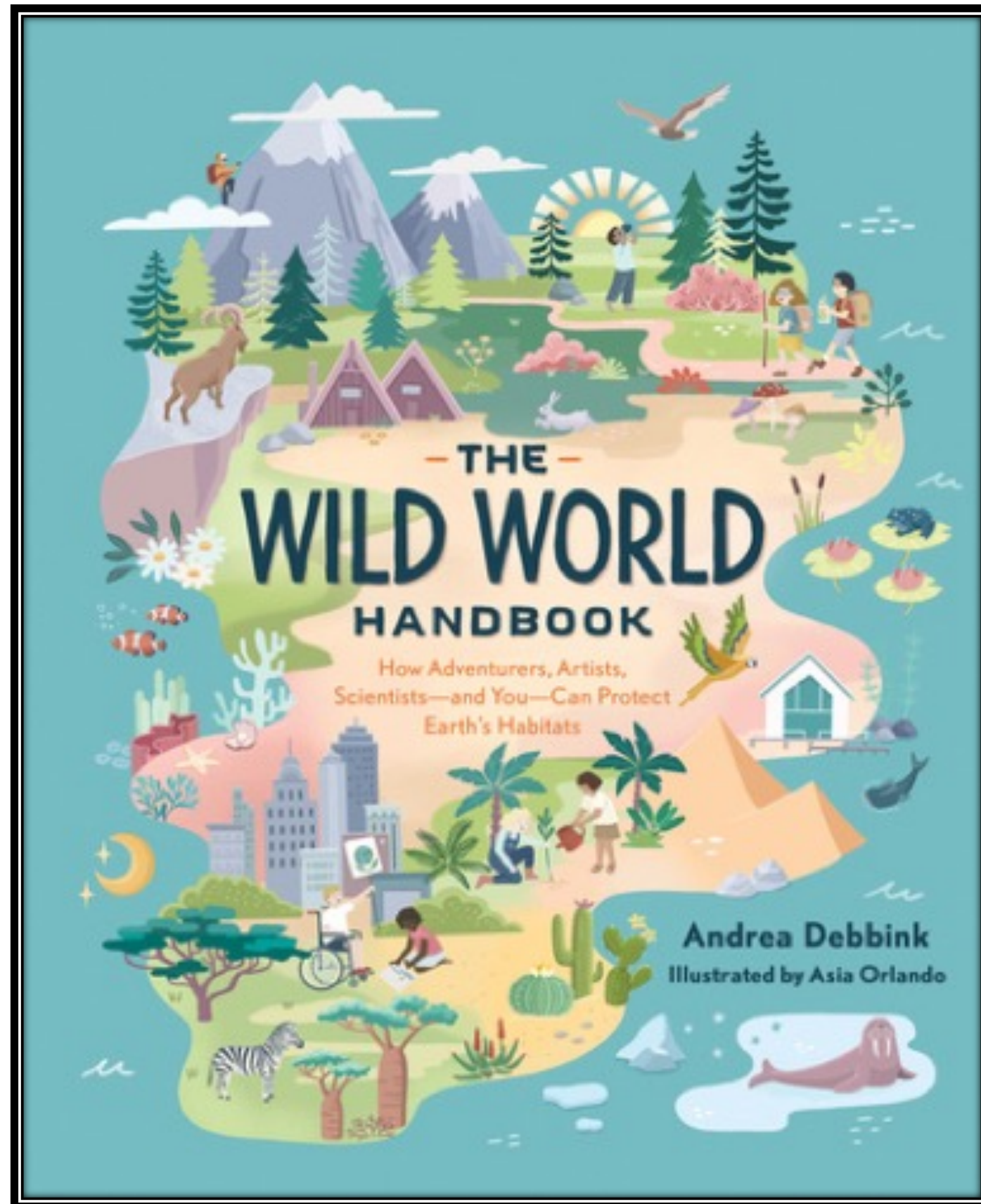

Packed with real-life tales of adventure, breathtaking illustrations, and practical tools, this handbook is an inspiring guide for the next generation of climate activists, conservationists, and nature lovers.

#### TARGET CONSUMER:

- Readers ages 8-12 who are concerned about climate change
- Teachers, librarians, and gatekeepers looking for accessible ways to discuss environmentalism with kids





## THE HIMALAYAS

Home to the world's largest peaks, the Himalayas are an ancient mountain range in Asia. Mount Everest gets a lot of attention as the world's tallest mountain, but it has plenty of impressive neighbors. Fifty Himalayan peaks rise more than 23,000 feet above sea level—that's more than four miles into the sky! At such a high altitude, the mountaintops are covered with snow year-round, which is how the range got its name. *Himā-laya* is a Sanskrit word that means "abode of snow." With climate change, however, that is drastically changing. Warming global temperatures are causing centuries-old glaciers to melt, and scientists are studying how such changes will affect the people and wildlife who depend on this region.

Today, the Himalayas are best known for capturing the imaginations of climbers. Each year, nearly a thousand people swarm to Nepal to climb Mount Everest. (In 2019, there were so many people trekking to the mountain's summit that chaotic "traffic jams" kept climbers stuck at dangerously high altitudes.) Besides the summit-seekers, every year more than 150,000 tourists visit the national park that surrounds Everest. Yet these incredible mountains are so much more than a playground for adventurers.

The massive Himalaya range extends 1,500 miles through five countries: Nepal, Bhutan, China, Pakistan, and India. The mountains shelter creatures like the elusive snow leopard, the Bengal tiger, the Himalayan marmot, the Alpine crane, and even a rare species of rhinoceros. And though the mountains are

### THE UNLIKELY MOUNTAINEER

## JUNKO TABELI

"When people meet me for the first time, they are surprised by my size. They expect me to be bigger than I am, more strapping, robust, like a wrestler for example. As I am the first woman to climb Mount Everest and the Seven Summits, they equate a certain body type to my accomplishments."

—Junko Tabei

The sun painted the clouds with streaks of light, and a young girl with shiny black hair paused to watch it. From where she stood at the top of a hill, she could see her whole world: the village below, the terraced vegetable fields cut into the hillsides, the winding river that flowed past her house, and the Buddhist temples that glowed like flame-colored castles in the sunset. The girl often pretended the largest temple was home to the Japanese emperor.

The girl's name was Junko Ishibashi. And like her village and her family's home, Junko was small. She was also often sick with high fevers and illnesses like pneumonia. Even now, another rattling sickness had settled in her lungs and made it hard to breathe. People said Junko was weak, even fragile. But one day, she would prove them wrong.

### First Summit

Junko was born at the beginning of the World War II in Miharu, Japan. Miharu was in valley far away from the bombing in southern Japan. Its name means "three springs" because every year, the peach, plum, and cherry trees all bloom at the same time, filling the valley with pink flowers and sweet-smelling air. In such a beautiful place, Junko could almost forget about the war. She spent her time playing outside with neighborhood children. They hung hammocks and rope swings in the trees pretending to be Tarzan, and they hiked to the tops of the highest hills in the village.

When Junko was in fourth grade, her teacher Mr. Watanabe invited her class on a summer camping trip to Nikko National Park, in northern Japan. Junko's class traveled by train and by bus to reach the park, where they would climb Mount Nasu. Junko had never been so far from home. Once the class arrived, it

took two days to hike to the top of the mountain.

Like many of Japan's mountains, Mount Nasu was a sleeping volcano. The hiking trail began at hot springs, a place where boiling water bubbled up from the earth and thick fog hung in the trees like ghosts. Each student carried a backpack stuffed with food, cooking pots, blankets, and extra clothes. That night as the class camped on the mountainside, they ate curry cooked over a fire and swam in the steaming hot springs.

The next morning, when the class finally reached the top of Mount Nasu, Junko was awestruck. As she gazed at the treetops below and the wide sky above, something shifted in her heart. For the first time, she began to wonder about all the adventures beyond her small valley. But more important, she realized something about herself. Tiny Junko, whom everyone called "weak," had climbed a mountain. All she had to do was keep putting one foot in front of the other. She knew she could do it again. And one day, she would.

### Climb On

Many years later, Junko went to college in Tokyo to study music. When she needed a break from city life, she hiked in the mountains outside Tokyo. She bought a guidebook full of maps and joined a student mountaineering club. During this time, Junko climbed many mountains, each one more difficult than the last.

After college, the mountains kept calling to her. Junko decided to join another mountaineering club, but this time, it was much more difficult to find one. In the 1960s, most mountaineering clubs didn't allow women as members. When Junko finally found a club to join, the members were different from others she had known. Most were rock climbers and used terms that Junko didn't under-

stand, like *carabiver* and *belay*. But Junko decided to give this unfamiliar sport a try. She eagerly accepted each invitation to climb with the club, confronting harder and harder routes throughout Japan.

### A Himalayan Adventure

In Japan at that time, it was unusual for women to have jobs or hobbies outside of their home and family. So, as Junko grew older, she faced pressure to give up climbing and get married instead. But Junko found a way to do both. In 1965, she married another climber named Masanobu Tabei, and together they devoted their lives to their hobby.

In 1969, Junko joined an all-women's mountaineering club that had an ambitious goal: to send a women-only team to climb a mountain in the legendary Himalayas. It was the first team of its kind in Japan. The women decided to travel to Nepal and climb Annapurna, a mountain with many summits over 23,000 feet. The expedition took more than three months. But on May 19, 1970, Junko and two of her teammates made it to the summit!

### Motherhood and Mountains

After their success on Annapurna, Junko and her teammates set their sights on Mount Everest, the tallest mountain in the world, at 29,029 feet. Junko had been just a teenager when two men, Sir Edmund Hillary and Tenzing Norgay, reached the summit of Mount Everest for the first time. Since then, no woman had made it to the top. Many people believed that women were not physically able to climb higher than 26,000 feet. They said that women's lungs couldn't handle the low oxygen and that their muscles weren't strong enough for such

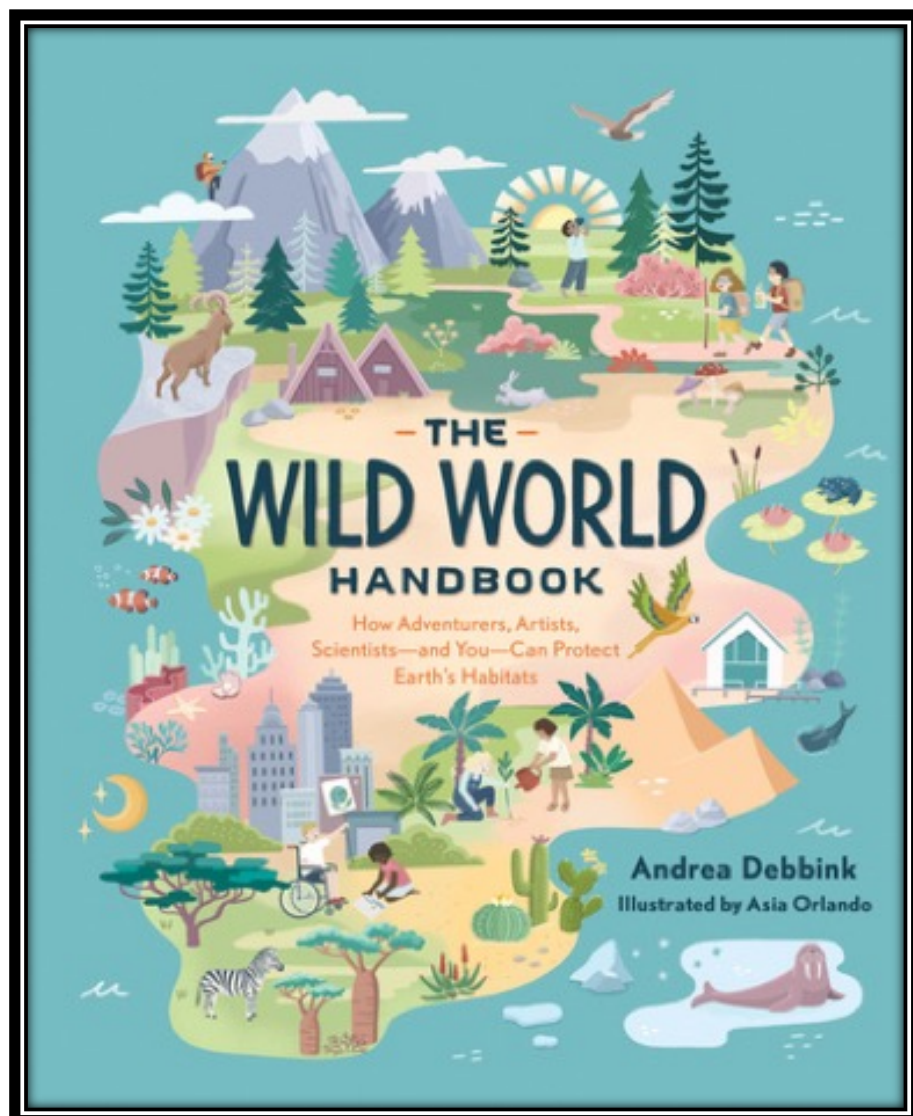

## The Wild World Handbook: Habitats

By Andrea Debbink, Illustrated by Asia Orlando

Quirk Books, May 2021

- AGE RANGE: 8 to 12
- SPECS: 232 pages, 6-7/8" x 8-1/2", 4 color
- SUBJECT AREAS:
  - BISAC 1: Juvenile Nonfiction – Science & Nature – Environmental Conservation
  - BISAC 2: Juvenile Nonfiction – Social Activism & Volunteering
  - BISAC 3: Juvenile Nonfiction – Science & Nature – Earth Sciences

The wonder of the natural world surrounds us—from the Amazon rainforest to the snowy peaks of Mount Everest to the green spaces in big cities. And as the threat of climate change grows, it's more important than ever to show appreciation for our planet by taking action.

The first book in a middle grade series for young environmental activists and nature lovers, *The Wild World Handbook* offers a roadmap for change and an invitation to explore the outdoors, alongside surprising facts and hands-on activities. Featuring nine habitats from around the globe, each section includes diverse biographies of outdoor adventurers, scientists, and artists who used their passion and skills to become bold allies for Earth's natural diversity and resiliency.

It's up to us to protect this beautiful, awe-inspiring planet we call home!

Inside you will find:

- Nine Amazing Habitats
- Eighteen Inspiring Biographies
- Nine Kid-Friendly DIY Activities
- Nine Fun Field Trips
- And much more!

# WILD WORLD HANDBOOK: CREATURES

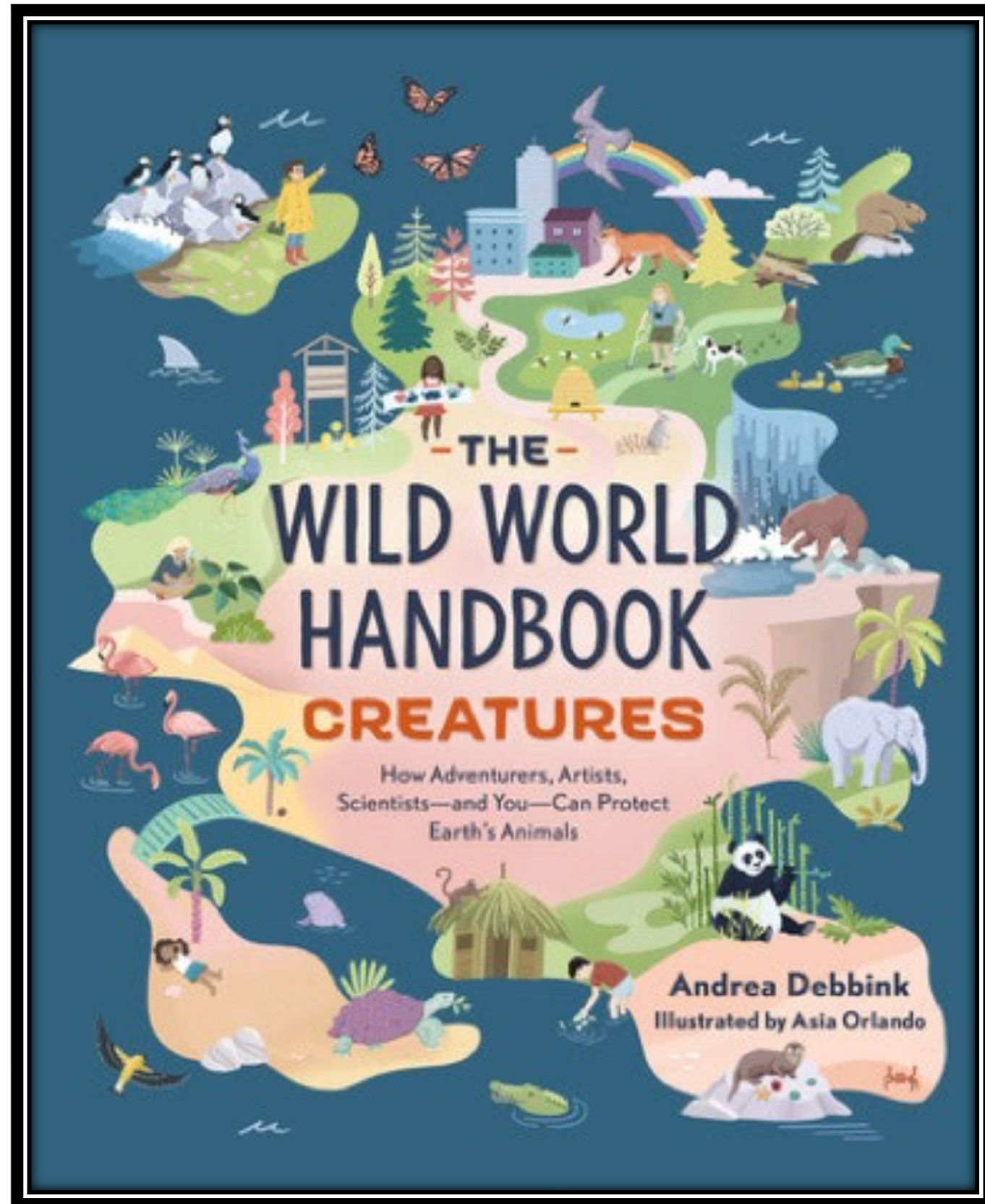

Packed with real-life tales of adventure, breathtaking illustrations, and practical tools, this handbook is an inspiring guide for the next generation of climate activists, conservationists, and nature lovers.

## TARGET CONSUMER:

- Readers ages 8-12 who are concerned about climate change
- Teachers, librarians, and gatekeepers looking for accessible ways to discuss environmentalism with kids

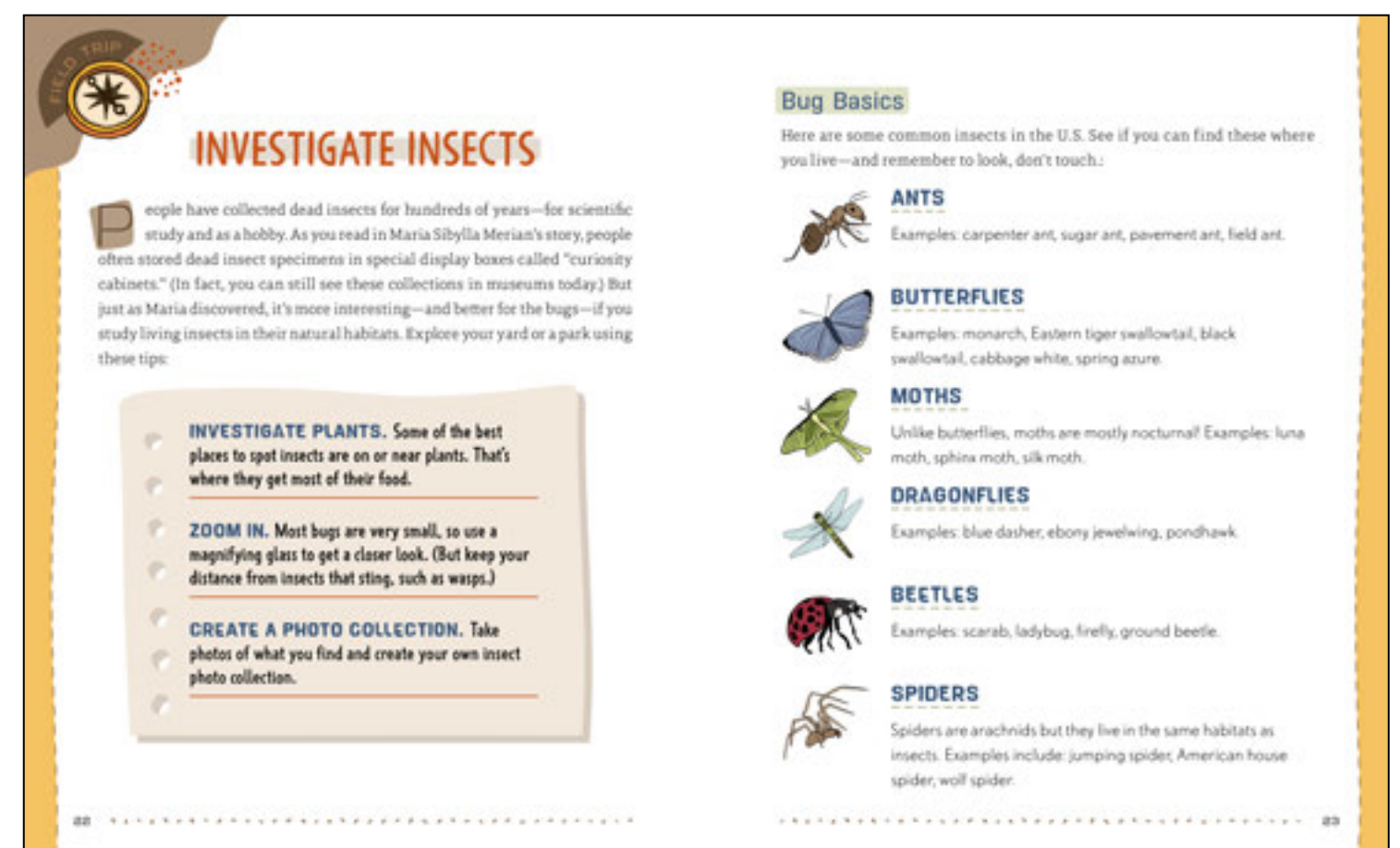



**BIOGRAPHY**

## THE BUTTERFLY ARTIST

### MARIA SIBYLLA MERIAN

APRIL 2, 1647–JANUARY 13, 1717

**P**eople said it was magic. They said the tiny creatures that appeared every summer were shapeshifters. What other explanation could there be? One day, nothing. The next day, the meadows were full of them, like delicate flowers that had fluttered right off their stems. Wings like soft petals. Fragile bodies as light as air. In the bright city gardens and the rolling farm fields, the creatures floated like fairies. In those days, people called them “summer birds.” But they also used the name we use today: butterflies.

And what about the other mysterious creatures? The ones that crawled and crept, hurried and scurried and hid. They seemed to appear overnight, digging into the flour bin, spinning silvery webs in the corner of a window. Magic, people said. But bad magic. The kind you should stomp out with the heel of your shoe or sweep away with a broom.

**An Unusual Hobby**

In Frankfurt—in the country known today as Germany—lived a girl named Maria Sibylla Merian. When Maria saw insects, she wasn't afraid. She was curious about each one, especially butterflies and moths. Maria spent hours crouched amid the leaves watching caterpillars crawl and taking detailed notes. But she did this in secret. It was a strange hobby for a young girl in the 1600s—or anyone.

When Maria was growing up, people didn't know much about insects. And rather than study them, they invented stories and superstitions. The most common theory was called “spontaneous generation.” People thought insects—along with other animals such as frogs—were evil beings that were magically formed from dust or mud. But Maria didn't believe this.

Maria's stepfather was Jacob Marrel, a talented artist who was famous for his still-life paintings. In that time and place, there were unfair rules about what women were allowed to paint. But Jacob ignored these rules. He thought his

“In my youth, I spent time investigating insects.”  
—Maria Sibylla Merian

14
15

stepdaughter had a gift and he encouraged Maria to paint the flowers and insects she loved. She spent years studying art and nature, spending long hours outdoors. Since girls didn't attend school, she studied natural history and Latin at home so she could read the scientific books of her day. (Back then, Latin was the universal language of science.) By the time Maria got married and had her first child, she was a successful watercolor artist who'd earned a reputation for her insect paintings.

**The Mind of a Scientist**

In those days, most nature artists observed dead specimens to create their art. Beetles and butterflies were killed and preserved like precious gems in special collections called “curiosity cabinets.” But Maria thought the best way to learn about insects was to study them in their natural habitats, to see how they lived. Maria took her art supplies into the fresh air, and in doing so, she made significant discoveries that other people missed.

During her observations, Maria witnessed a mysterious process scientists and scholars had begun to ponder, known as “metamorphosis.” Metamorphosis comes from a Greek word meaning “transformation.” They noticed that some animals changed in dramatic ways. Maria had seen this for herself as she watched caterpillars become moths and butterflies. In 1679, when she was thirty-two years old, Maria published a book about metamorphosis called *The Wondrous Transformation of Caterpillars*, filled with illustrations of insects transforming from egg to caterpillar to pupa and finally to moths and butterflies. Eventually, Maria's work would help disprove the idea of spontaneous generation. Insects didn't magically appear, they came from eggs. And they weren't evil shapeshifters, they were intriguing animals.

Wealthy collectors bought Maria's art, and in turn, they shared their exquisite insect collections with her. It was in one collector's “curiosity cabinet” that

16
17

**FIELD TRIP**

## INVESTIGATE INSECTS

**P**eople have collected dead insects for hundreds of years—for scientific study and as a hobby. As you read in Maria Sibylla Merian's story, people often stored dead insect specimens in special display boxes called “curiosity cabinets.” (In fact, you can still see these collections in museums today.) But just as Maria discovered, it's more interesting—and better for the bugs—if you study living insects in their natural habitats. Explore your yard or a park using these tips:

**INVESTIGATE PLANTS.** Some of the best places to spot insects are on or near plants. That's where they get most of their food.

**ZOOM IN.** Most bugs are very small, so use a magnifying glass to get a closer look. (But keep your distance from insects that sting, such as wasps.)

**CREATE A PHOTO COLLECTION.** Take photos of what you find and create your own insect photo collection.

**Bug Basics**

Here are some common insects in the U.S. See if you can find these where you live—and remember to look, don't touch:

- ANTS**  
Examples: carpenter ant, sugar ant, pavement ant, field ant.
- BUTTERFLIES**  
Examples: monarch, Eastern tiger swallowtail, black swallowtail, cabbage white, spring azure.
- MOTHS**  
Unlike butterflies, moths are mostly nocturnal! Examples: luna moth, sphinx moth, silk moth.
- DRAGONFLIES**  
Examples: blue dasher, ebony jewelwing, pondhawk.
- BEETLES**  
Examples: scarab, ladybug, firefly, ground beetle.
- SPIDERS**  
Spiders are arachnids but they live in the same habitats as insects. Examples include: jumping spider, American house spider, wolf spider.

20
21

**DIY**

## A CURIOUS COLLECTION

Early insect collectors filled cabinets with their specimens or pinned them to paper. Now we know that it's best to leave insects where we find them and admire them in the wild. But with a little creativity, you can still “collect” the ones you see.

**Supplies**

- Card stock
- Picture frame (without the glass)
- Pencil
- Colored pencils or markers
- Scissors
- Craft glue

**Instructions**

1. Cut a piece of card stock to fit inside the picture frame. Place the card stock inside the frame and fasten the back to hold it in place. (Use a small frame for a single “specimen” or a larger frame if you plan to build up a collection.)
2. Whenever you see an insect or take a photo of one, draw it on a piece of card stock. Use colored pencils or markers to color it in.
3. Use scissors to cut out the drawing. (If the insect has wings, fold the drawing lengthwise along the middle to give it a 3D effect.)
4. Use a dab of craft glue to attach the insect to the framed card stock. Write the name of the species underneath. Keep adding to your collection as you discover more insects! (Or use the insects you find to inspire your own imaginary versions.)

22
27

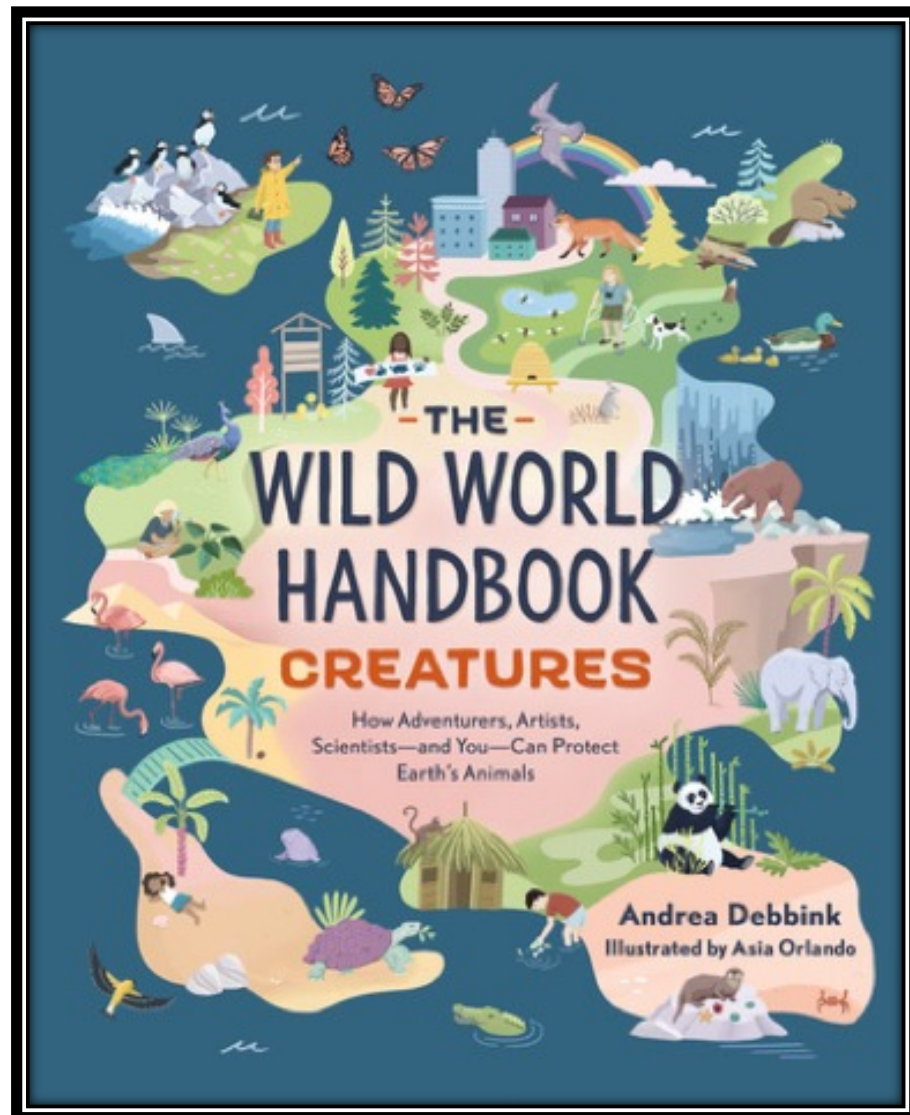

## **The Wild World Handbook: Creatures** **By Andrea Debbink, Illustrated by Asia Orlando** **Quirk Books, November 2021**

- AGE RANGE: 8 to 12
- SPECS: 232 pages, 6-7/8" x 8-1/2", 4 color
- SUBJECT AREAS:
  - BISAC 1: Juvenile Nonfiction – Science & Nature – Environmental Conservation
  - BISAC 2: Juvenile Nonfiction – Social Activism & Volunteering
  - BISAC 3: Juvenile Nonfiction – Animals

We share this beautiful planet we call home with countless living creatures, from monarch butterflies and falcons to koalas and dolphins. And just like us, animals everywhere are faced with the growing threat of climate change.

Featuring seven categories of animals, this handbook offers a roadmap for change and an invitation to explore the outdoors with fascinating facts, hope-filled stories, and hands-on STEAM activities. Each section includes biographies of adventurers, scientists, and artists from all over the world who used their passion and skills to become bold allies for nature.

As the second of two illustrated middle grade guides, *The Wild World Handbook: Creatures* seeks to empower young readers to appreciate and protect Planet Earth and its inhabitants.

Inside you will find:

- Seven Incredible Categories of Creatures
- Fourteen Inspiring Biographies
- Seven Kid-Friendly DIY Activities
- Seven Fun Field Trips
- And much more!

# LITTLE KID, BIG CITY!



Kids pick their own path through the most exciting cities in the world in Little Kid, Big City!

With fun and little-known facts about locations, a resource section of useful information, prompts to choose which way to travel next, and a foldout map of each city, this series will delight kids on the move or those who want to learn about locales far from home.

Rights Sold: Spanish, Galician

TARGET CONSUMER:

- Readers ages 8-12 who love to learn about new ideas and places with nonfiction
- Families who are taking a trip to one of the destinations and want to inspire curiosity and excitement for new places





# LITTLE KID, BIG CITY!

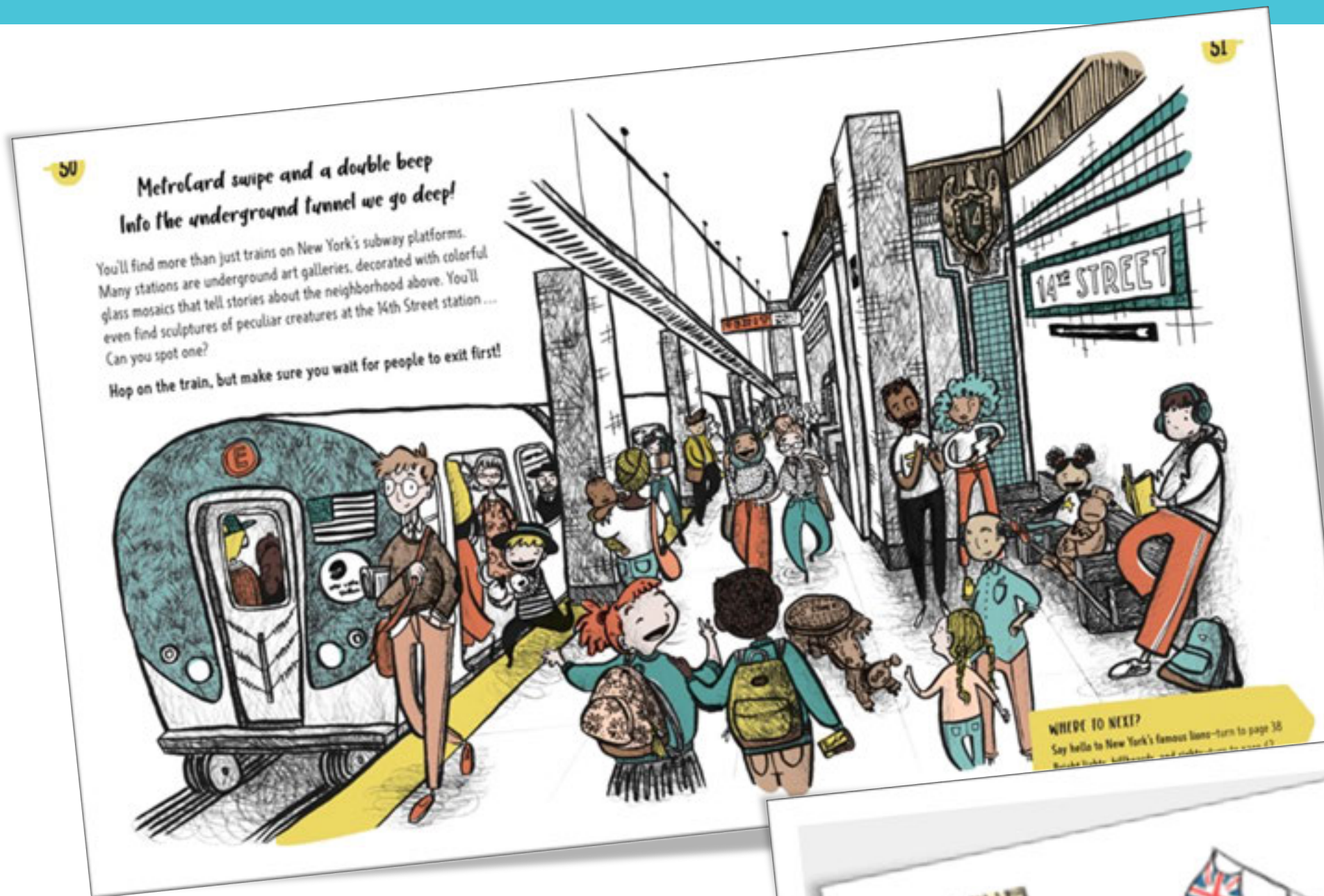

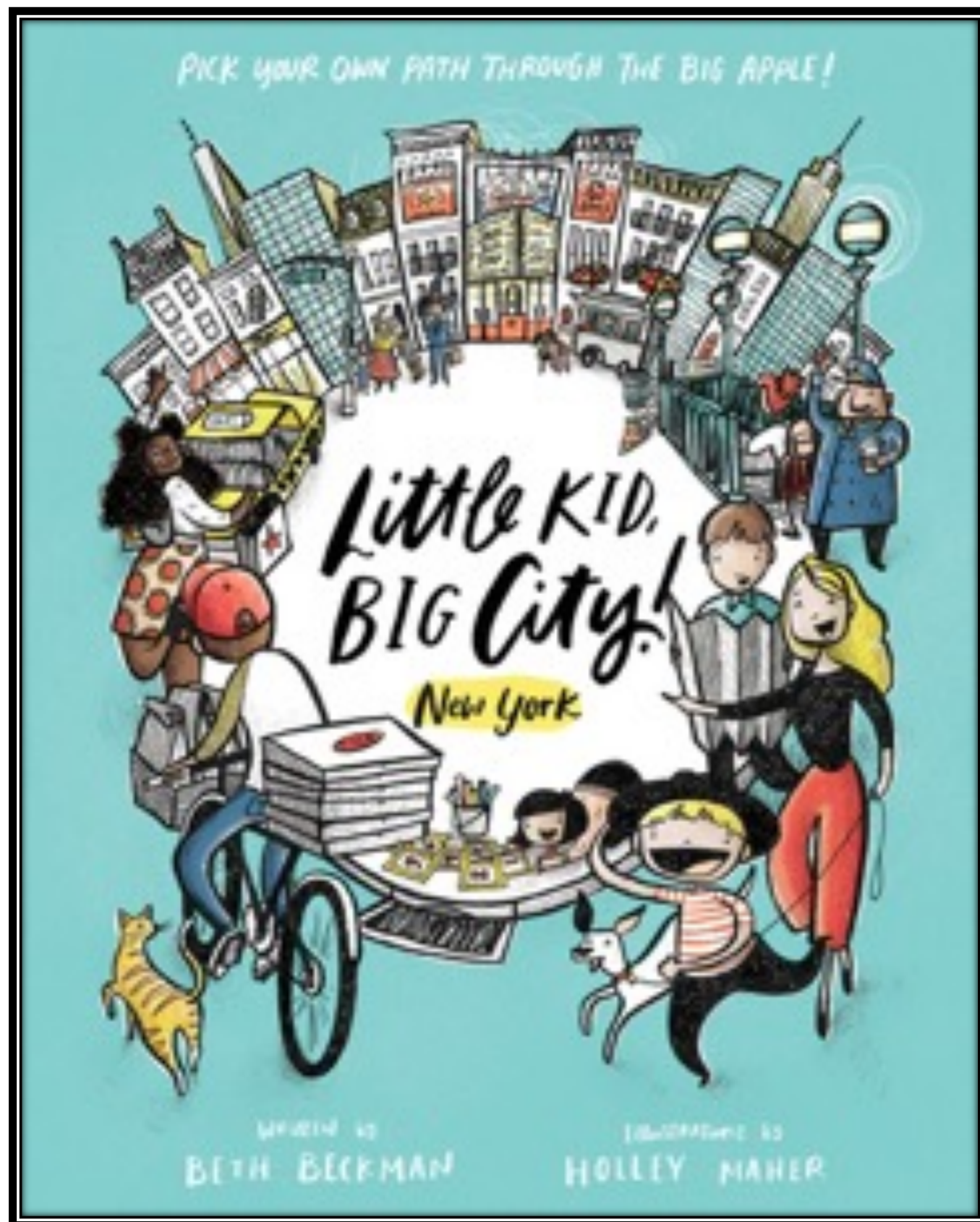

## Little Kid, Big City! New York

Beth Beckman; illustrated by Holley Maher

February 2021

\$19.99 / Hardcover / 8-12 years

88 Pages | 8 x 10

If you could have an adventure in New York, where would you go? Curious kids will find plenty of sights, smells, and tastes to explore in this illustrated pick-your-own-path travel guide series.

Would you walk the Brooklyn Bridge for a huge slice of pizza, see the dazzling lights in Times Square, or visit the whale at the Museum of Natural History?

Create your own itinerary, choose which places to visit at the end of every page, and follow along with an adventurous family as they explore New York.

Whether you're an armchair traveler or a real-life tourist, *Little Kid, Big City!* has everything you need to invent your own adventure!



# Little Kid, Big City! London

Beth Beckman; illustrated by Holley Maher

June 2021

\$19.99 / Hardcover / 8-12 years

88 Pages | 8 x 10

If you could have an adventure in London, where would you go? Curious kids will find plenty of sights, smells, and tastes to explore in this illustrated pick-your-own-path travel guide series.

Would you hop on the Tube to visit Buckingham Palace, find a tasty lunch on Brick Lane, or pass the time with Big Ben?

Create your own itinerary, choose which places to visit at the end of every page, and follow along with an adventurous girl and her two moms as they explore London.

Whether you're an armchair traveler or a real-life tourist, *Little Kid, Big City!* has everything you need to invent your own adventure!

# WORST CASE SCENARIO JR



## About the WORST CASE SCENARIO JUNIOR series:

From braces, bullies, and chores to piranhas, spiders, and jellyfish, the world can be full of perils. But never fear... these books come to the rescue, featuring everything a kid needs to survive a school dance, deal with being grounded, deal with a charging elephant, or go to the bathroom in the woods!

Super funny, surprisingly useful, 100% factual.

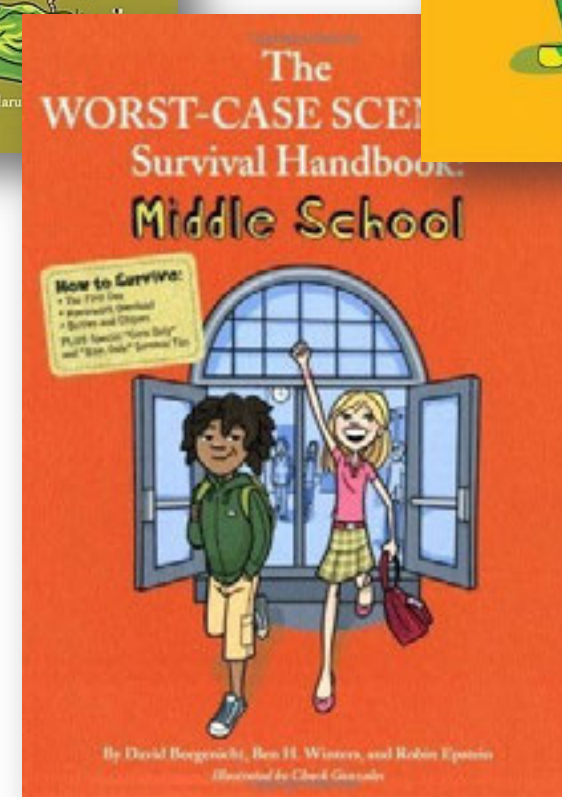
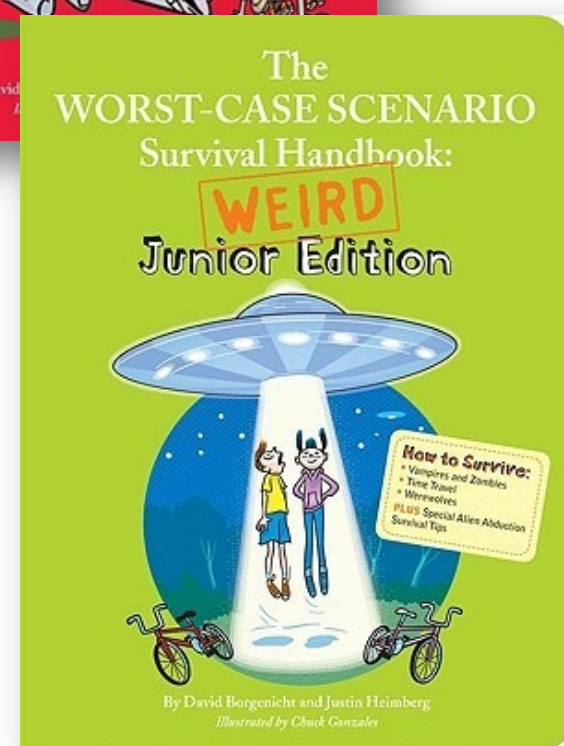
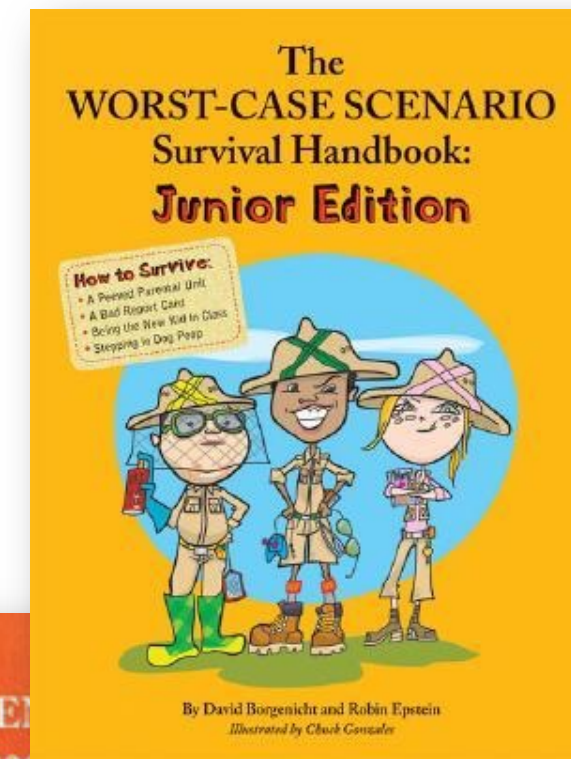
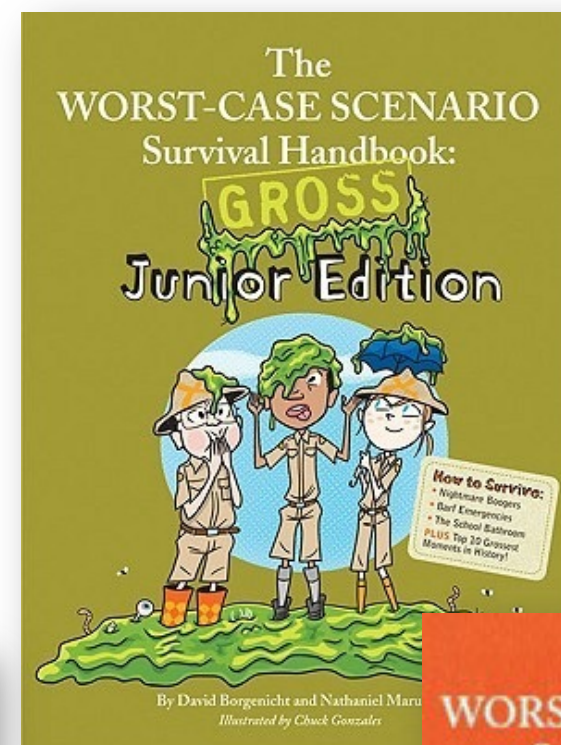
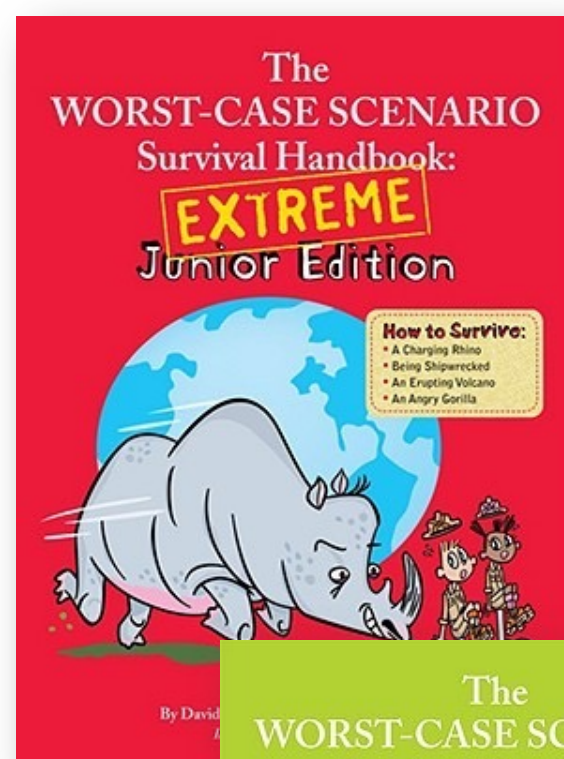

# NOODLEMANIA!



## **Noodlemania!**

By Melissa Barlow

May 2013

Age range: 6-9

50 playful pasta recipes so simple and fun that kids can make them!

You'll go noodle crazy with the playful and colorful pasta recipes in *Noodlemania!* It's filled with hot and cold main dishes, salads, and even desserts! Try Super Stuffed Monster Mouths made with jumbo pasta shells, Rapunzel pasta made with extra-long spaghetti, Spider Cookies made with crunchy ramen noodles, or Gloppy Green Frog Eye Salad made with acini di pepe. *Noodlemania!* also teaches basic math skills and includes fun trivia. Which pasta name means "little ears"? What's the world record for the largest meatball ever made? Kids will have fun in the kitchen while sharpening their cooking skills with *Noodlemania!*



For more info: [rights@quirkbooks.com](mailto:rights@quirkbooks.com)

All translation rights available.

# PHOTO DOODLES



## Photo Doodles: 200 Photos for You to Complete

By ViiiZ

August 2013

**You've never seen an activity book quite like this one!**

*Photo Doodles* combines kid-friendly photographs and cool creative challenges into the perfect canvas for anyone capable of wielding a crayon. Young artists can complete dozens of fun and playful pictures of everything from roller coasters and soda cans to book covers and palaces.

Rights sold: Dutch (BBNC) Japanese (Bunkyosha)

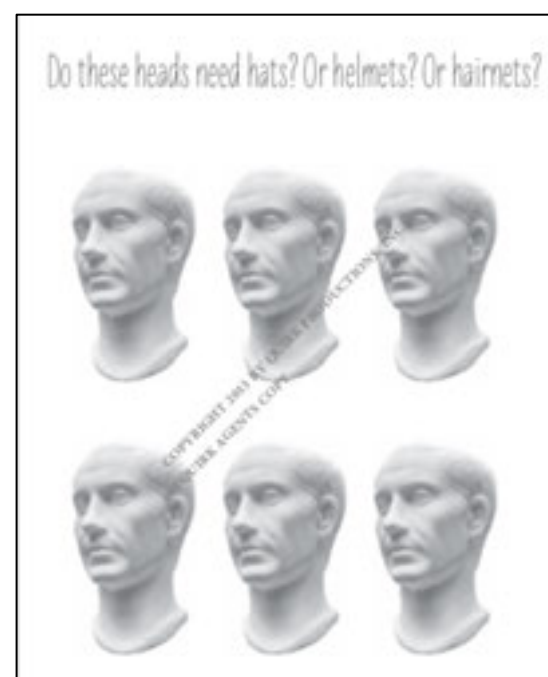

For more info: [rights@quirkbooks.com](mailto:rights@quirkbooks.com)

# MONKEYFARTS!



## Monkeyfarts!

By David Borgenicht

September 2012

Wacky jokes every kid should know!

From classic favorites to zany newcomers, *Monkeyfarts!* is packed to bursting with wild and wacky jokes about monsters, pirates, polar bears, super-heroes, hot dogs, Harry Potter, Vikings, elephants, vampires, and more. With hilarious jokes and bold illustrations, it's the only joke book you'll ever need. Who doesn't love Monkeyfarts?!

- Age range: 6-9 years

All translation rights available.

For more info: [rights@quirkbooks.com](mailto:rights@quirkbooks.com)

# FRED ROGERS TITLES



## A Beautiful Day in the Neighborhood

By Fred Rogers

March 2019

### The *New York Times* Best Seller

For the first time ever, beloved poems from childhood psychology expert Fred Rogers are collected in this charmingly illustrated treasury.

From funny to sweet, silly to sincere, the poems of Mister Rogers explore such universal topics as feelings, new siblings, everyday life, imagination, and more. Through these songs, Mister Rogers instilled in his young viewers the values of kindness, self-awareness, and self-esteem. But most of all, he taught children that they are loved, just as they are. Perfect for bedtime, sing-along, or quiet time alone.

Rights sold: Romanian (Didactica)

Also Available:

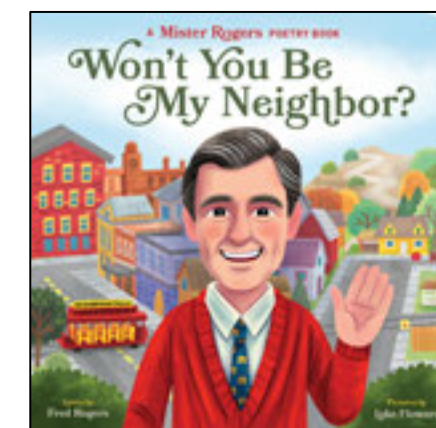
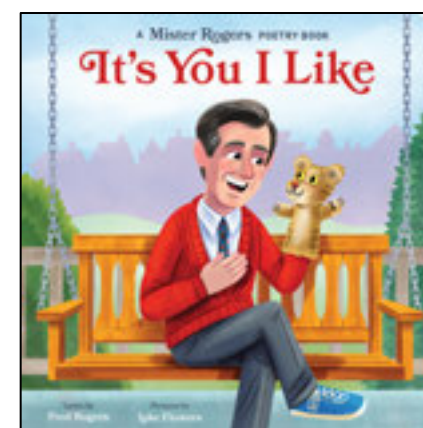
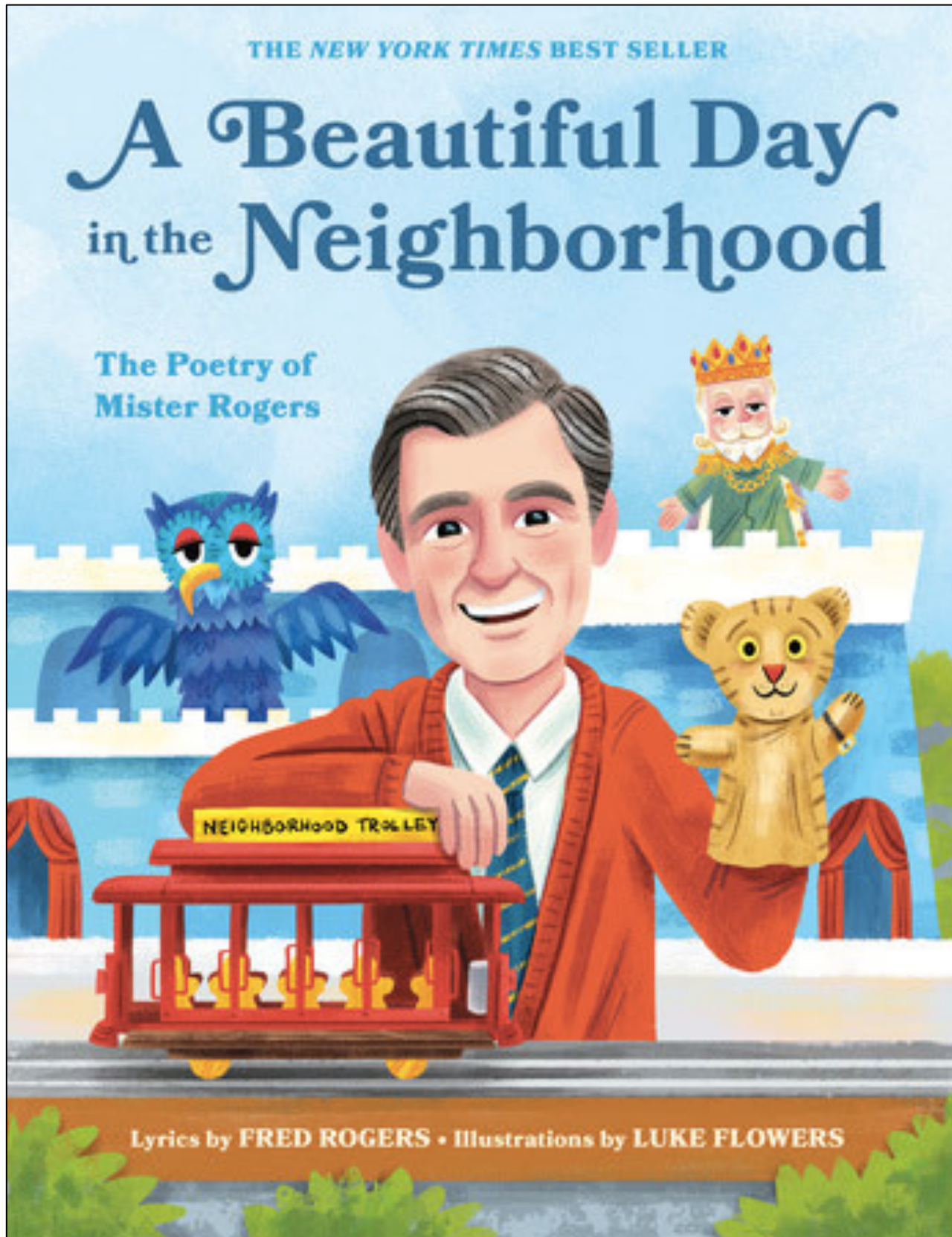

For more info: [rights@quirkbooks.com](mailto:rights@quirkbooks.com)



**YOUNG  
ADULT**

FICTION

# STARS, HIDE YOUR FIRES



## Stars, Hide Your Fires

By Jessica Best

July 2023

**A wanted thief. A murdered emperor. A killer loose on the station.**

***Knives Out* goes sci-fi in this gripping YA mystery set in space.**

### **TARGET CONSUMER:**

- Teen readers of YA science fiction and fantasy, such as *The Darkness Outside Us* and *Iron Widow*
- Readers of LGBTQ science fiction and fantasy, such as *Gideon the Ninth* and the *Wayfarers* series

All translation rights available.

For more info: [rights@quirkbooks.com](mailto:rights@quirkbooks.com)



## About The Book:

“A delightfully mischievous adventure full of intrigue, betrayal, and a touch of romance. Get ready to join your new favorite rebel crew.”—Dahlia Adler, author of *Cool For The Summer*

A wanted thief. A murdered emperor. A killer loose on the station. *Knives Out* goes sci-fi in this gripping YA mystery set in space.

As an expert thief from a minor moon, Cass knows a good mark when she sees one. The emperor’s ball is her chance to steal a fortune for herself, her ailing father, and her scrappy crew of thieves and market vendors.

Her plan is simple:

First, hitch a ride to the planet of Ouris, the dazzling heart of the empire.

Then, sneak onto the imperial palace station to attend the emperor’s ball.

Finally, steal from the rich, the royal, and the insufferable.

But on the station, things quickly go awry. When the emperor is found dead, everyone in the palace is a suspect—and someone is setting Cass up to take the blame. To clear her name, Cass must work with an unlikely ally: a gorgeous and mysterious rebel with her own reasons for being on the station. Together, they unravel a secret that could change the fate of the empire.



## Praise for STARS, HIDE YOUR FIRES:

“With **lush worldbuilding**, high stakes, and a page-turning mystery, *Stars, Hide Your Fires* is impossible to put down. **Brilliantly crafted and delightfully fast-paced.**”—Rachael Lippincott, #1 *New York Times* bestselling co-author of *She Gets the Girl*

“A delightfully mischievous **adventure full of intrigue, betrayal, and a touch of romance**. Get ready to join your new favorite rebel crew.”—Dahlia Adler, author of *Cool for the Summer*

“A delightful and gripping space mystery with **twists and more twists**; a charming and unlikely detective team; an adorable, bantery romance; and an extravagant sci-fi ball! I thoroughly enjoyed this fun romp of a read!”—Vanessa Len, author of *Only a Monster*

“An astonishing work of young adult science fiction. Electric, **unflinching characters** grip the reader from page one and refuse to let go, hurtling headfirst into a story shot through with unmatched worldbuilding and a murder mystery for the (space) ages.”—Zoe Hana Mikuta, author of *Gearbreakers*

“*Succession* meets space in this twist-filled **examination of the impact of imperial war** across social classes—and **the idealistic revolutionary and jaded con artist** forging a delightful sapphic love story along the way. Jessica Mary Best doesn't hide her fire in this engaging novel.”—Miel Moreland, author of *It Goes Like This* and *Something Like Possible*

“A twisty and propulsive spectacle **full of banter and ballgowns**. *Stars, Hide Your Fires* is the sapphic murder mystery in space of my dreams! This glittering space opera is sure to delight fans of Beth Revis and Amie Kauffman.”—Rosiee Thor, author of *Tarnished Are the Stars*

“An **edge-of-your-seat genre-bender** with a ton of heart! Can't wait to read what Best writes next!”—Alechia Dow, author of *The Sound of Stars*



## About the Author



**Jessica Mary Best** is a multi-award-winning freelance writer/editor, an amateur singer/songwriter and a well-intentioned ball of pure quivering anxiety. She is based out of Columbus, Ohio.

## Specs and Data:

- **KEY DATES:** ARC Available Now Publishes July 2023
- **SPECS:** 304 pages, 5-1/2" x 8-1/2", 1 color
- **SUBJECT AREAS:**
  - **BISAC 1:** Young Adult Fiction – Science Fiction – Space Opera
  - **BISAC 2:** Young Adult Fiction – Mysteries & Detective Stories
  - **BISAC 3:** Young Adult Fiction – Romance – LGBTQ+
- **RIGHTS SOLD:** All translation rights available

# THIS IS NOT THE JESS SHOW



## This Is Not the Jess Show

By Anna Carey  
February 2022

In this riveting duology by Anna Carey, a teenage girl discovers her entire life has been livestreamed as entertainment for the masses.

"A fantastically smart, funny, and thoughtful thriller about how our devices manipulate and exploit our closest relationships."

—Nicola Yoon, #1 *New York Times* bestselling author of *Everything, Everything* and *The Sun Is Also a Star*

### TARGET CONSUMER:

- Teens who crave fast-paced thrillers like *One Of Us Is Lying*, or thrillers with speculative twists like the *Delirium* trilogy by Lauren Oliver
- Adult readers who enjoy YA and are fascinated by reality TV and influencer culture

All translation rights available.

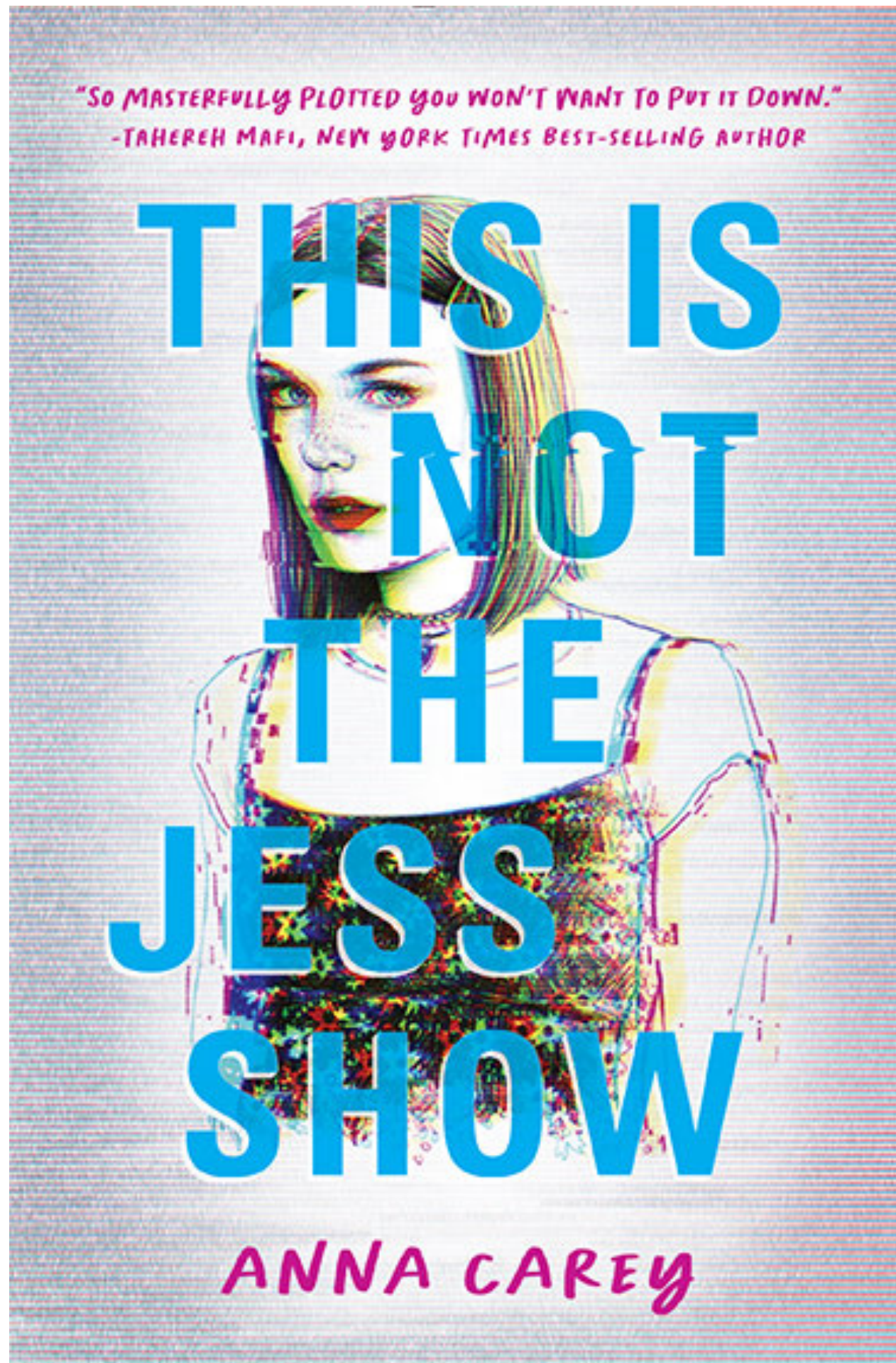

For more info: [rights@quirkbooks.com](mailto:rights@quirkbooks.com)



## About The Book:

“At once thought-provoking and hilarious, *This Is Not the Jess Show* is a timely, incisive book so masterfully-plotted you won't want to put it down.”—Tahereh Mafi, *New York Times* best-selling author of the *Shatter Me* series and *A Very Large Expanse of Sea*

The year is 1998: the Spice Girls are dominating the airwaves, butterfly clips are all the rage, and *Titanic* has just won a bunch of Oscars. Like any other teenager, Jess Flynn is just trying to survive high school. Between a crush on her childhood best friend, overprotective parents, and her sister's worsening health, the only constant is her hometown of Swickley, which feels smaller by the day.

Jess is resigned to her small-town life until she discovers a mysterious device with an apple logo, causing her to question everything and everyone she's ever known. As more cracks appear in Jess's world, she must choose: live the rest of her life knowing it's a lie or risk everything for the truth.

A fast-paced, mind-bending YA thriller packed with '90s pop culture references and perfect for fans of *Black Mirror*, *This Is Not the Jess Show* will keep readers guessing until the very end.

15,000  
Copies  
Sold

# THIS IS NOT THE REAL WORLD

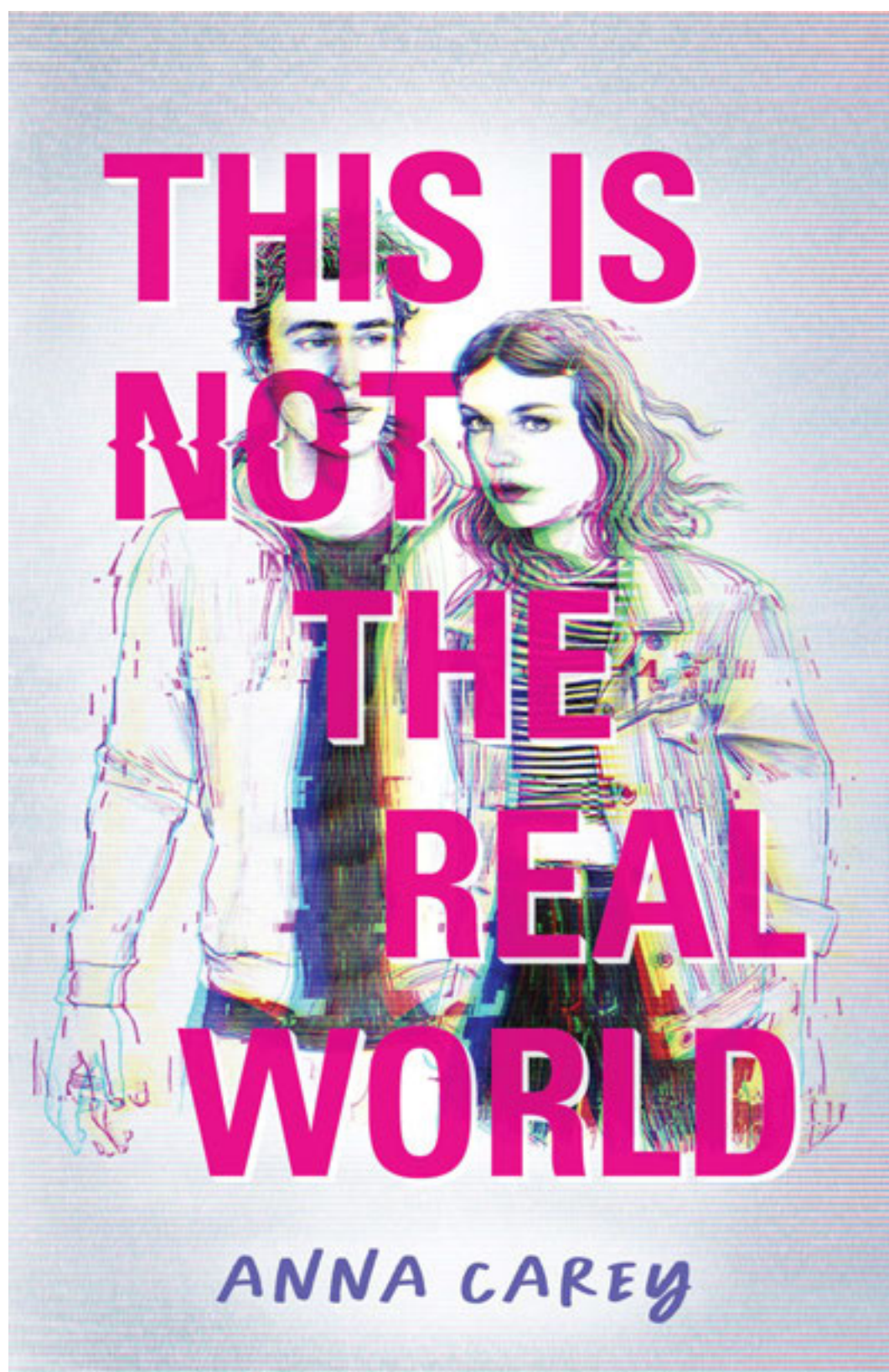

## This Is Not the Real World

By Anna Carey

May 2022

A sequel to *This Is Not the Jess Show*

In the explosive, twisty sequel to *This Is Not the Jess Show*, 18-year-old Jess is out for revenge as she confronts the corrupt media empire that documented every moment of her childhood.

### TARGET CONSUMER:

- Readers of THIS IS NOT THE JESS SHOW
- YA mystery/thriller readers
- Teens and Gen Z/millennial adults who are fascinated by reality TV and influencer culture

All translation rights available.

For more info: [rights@quirkbooks.com](mailto:rights@quirkbooks.com)





## About The Book:

Nineties nostalgia takes a dark turn in this thrilling sequel to *This Is Not the Jess Show*, perfect for readers of *We Were Liars* and *One of Us Is Lying*.

Months after Jess escaped from the set of *Stuck in the '90s*, the nostalgic reality show she believed was her real life, the teen star is getting to know the outside world for the first time. But she can't outrun her fictional life forever—or the media empire that owns it.

After Like-Life Productions tracks her down and forces her boyfriend to return to the show, Jess teams up with an underground network fighting to uncover Like-Life's schemes. To expose the truth, Jess must go back to the set and take Like-Life down from the inside . . . but getting revenge might just cost her everything.



## Praise for THIS IS NOT THE JESS SHOW:

"It's a dark and distorted mirror of our own extremely strange times, perfect reading for anyone who wants to feel seen without necessarily needing to be looked at."—*Shondaland*

"I read this in a single, compulsive sitting. A fantastically smart, funny, and thoughtful thriller about how our devices manipulate and exploit our closest relationships."—*Nicola Yoon*, #1 *New York Times* bestselling author of *Everything, Everything* and *The Sun Is Also a Star*

"At once thought-provoking and hilarious, *This Is Not the Jess Show* is a timely, incisive book so masterfully-plotted you won't want to put it down."—*Tahereh Mafi*, *New York Times* Bestselling author of the *Shatter Me* series and *A Very Large Expanse of Sea*

"Nostalgic, romantic, thrilling, and with an exciting twist, I devoured *This Is Not The Jess Show* and didn't want it to end!"—*Sara Shepard*, #1 *New York Times* bestselling author of *Pretty Little Liars* and *The Lying Game*

"A thrilling and thought-provoking ride."—*Kirkus Reviews*

"*This is Not the Jess Show* goes deep in exploring how people live their lives and create their own realities—sometimes at a cost."—*Foreword Reviews*

"The fast-paced, intricate plot ramps up Jess's paranoia and frustration, both of which are vividly expressed through her first-person narrative."—*Booklist*

"A fun and thoughtful thriller; this YA novel will please fans of E. Lockhart and Kiera Cass."—*School Library Journal*

"Fast paced and thrilling."—*Bulletin for the Center of Children's Books*



## About the Author



Anna Carey is the author of several books for teens including *This is Not The Jess Show*, *This is Not the Real World*, and the *Eve* trilogy. She lives in Los Angeles.

## Specs and Data:

- **KEY DATES:** PDF Available Now Publishes May 2022.
- **SPECS:** 304 pages, 5-1/2" x 8-1/2", 1 color
- **SUBJECT AREAS:**
  - **BISAC 1:** Young Adult Fiction – Thrillers & Suspense
  - **BISAC 2:** Young Adult Fiction – Dystopian
  - **BISAC 3:** Young Adult Fiction – Mysteries & Detective Stories
- **RIGHTS SOLD:** All translation rights available

# LYCANTHROPY AND OTHER CHRONIC ILLNESSES

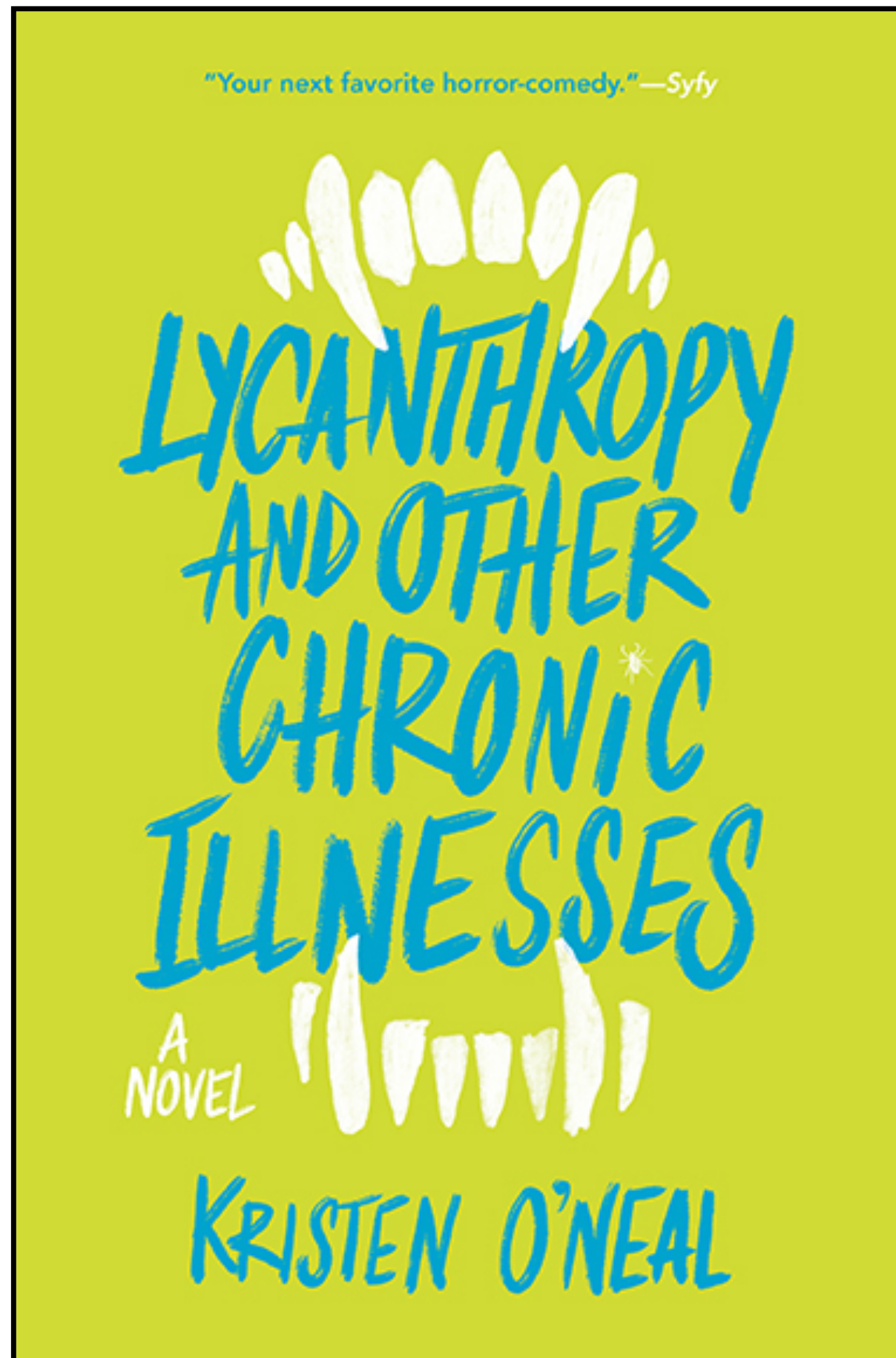

## Lycanthropy And Other Chronic Illnesses

By Kristen O'Neal

Paperback coming May 2022

"Emotional, thoughtful, and a true testament to the power of friendship, *Lycanthropy and Other Chronic Illnesses* is a werewolf novel that will make you look at navigating illness, supernatural or not, in a whole new way....O'Neal breaks new ground with this book and accomplishes something truly wonderful." —*Locus Magazine*

### TARGET CONSUMER:

- Older Gen Z and younger Millennial women who enjoy young adult fiction across multiple genres
- Fans of smart, funny Netflix shows for teens like *The Chilling Adventures of Sabrina* and movies like *Set It Up*
- Readers who are interested in the experience of chronic illness

For more info: [rights@quirkbooks.com](mailto:rights@quirkbooks.com)

All translation rights available.



## About The Book:

*Teen Wolf* meets *Emergency Contact* in this sharply observed, hilarious, and heartwarming debut young adult novel about friendship, chronic illness, and . . . werewolves.

Priya worked hard to pursue her pre-medical school program dreams at Stanford, but the fallout from undiagnosed Lyme disease sends her back to her childhood home in New Jersey during her sophomore year—and leaves her wondering if she'll ever be able to return to the way things were.

Thankfully she has her online pen pal, Brigid, and the rest of the members of “oof ouch my bones,” a virtual support group that meets on Discord to crack jokes and vent about their own chronic illnesses.

When Brigid suddenly goes offline, Priya does something out of character: she steals the family car and drives to Pennsylvania to check on Brigid. Priya isn't sure what to expect, but it isn't the horrifying creature that's shut in the basement.

With Brigid nowhere to be found, Priya begins to puzzle together an impossible but obvious truth: the creature might be a werewolf—and the werewolf might be Brigid. As Brigid's unique condition worsens, their friendship will be deepened and challenged in unexpected ways, forcing them to reckon with their own ideas of what it means to be normal.



## Key Selling Points:

- **HIGHLY PRAISED IN HARDCOVER:** A Spring 2021 Indie Next pick, a ParnassusNext selection for May 2021, and well-reviewed in Booklist, School Library Journal, and Kirkus.
- **RELEVANT BUT UNDEREXPLORED TOPIC:** Chronic illnesses—i.e. incurable and ongoing conditions—affect roughly 40% of the population, but the experience is rarely reflected in fiction at any audience level. *Lycanthropy* offers teens who struggle with these conditions a fresh way to see themselves, and offers essential insight for those who don't.
- **FRESH, APPEALING VOICE:** Kristen O'Neal's voice is perfect for young Millennials and Gen Z readers looking for novels that perfectly reflect the way young adults speak to each other and online. The wise-cracking, pop-culture-dense dialogue will be a huge selling point for readers.
- **AUTHOR WRITES FROM EXPERIENCE:** O'Neal uses her history with celiac disease to create lived-in experiences that will resonate with chronic illness sufferers while also turning chronic illness into an opportunity for mystery, drama, and humor.



## Praise for LYCANTHROPY AND OTHER CHRONIC ILLNESSES:

Kids Indie Next Pick for Spring 2021

One of POPSUGAR's Best YA Books of April

A SIBA Read This Next Selection for Spring 2021

"Emotional, thoughtful, and a true testament to the power of friendship, *Lycanthropy and Other Chronic Illnesses* is a werewolf novel that will make you look at navigating illness, supernatural or not, in a whole new way....**O'Neal breaks new ground with this book** and accomplishes something truly wonderful."—*Locus Magazine*

"Your next favorite horror-comedy."—Syfy Fangrrls

"O'Neal persuasively pulls from her own experience with chronic illness to inform her depiction of the topic, using interactions between support group members to **layer comedic banter and vulnerability** that specifically addresses aspects of disability experiences."—*Publishers Weekly*

"A **heartwarming**, quirky take on chronic illness in all its hairy detail."—*Kirkus Reviews*

"A **fresh and original** twist on the werewolf legend."—*Booklist*

"A **must-read** for anyone with a chronic illness or who loves someone with a chronic illness."—*School Library Journal*

"An **electric tour de force of hilarity and humanity**. Oof, ouch, my heart! It bleeds for this book."—Preston Norton, author of *Where I End and You Begin*

"**Poignant and hilarious**....a great recommendation for readers who are looking for a solid friendship-themed book."—Candice Conner, The Haunted Book Shop

# ONCE UPON A CON



Your favorite fairy tales take to the page as geeky, funny, and adorably romantic contemporary YA novels. A handsome sci-fi prince falls for a passionate fangirl. Hollywood's geeky leading lady swaps places with an ordinary con-going girl who could be her twin. A bookish, small-town girl finds herself drawn to a newcomer with a mysterious past in a secluded mansion. Hijinks, hilarity, and sweet love stories ensue. Perfect for contemporary YA fans, geeks, cosplayers, and any readers who believe in the magic of fandom.

**Select translation rights available.** French (Lumen Éditions), Polish (WeNeedYA), and Turkish (Yabancı) rights sold.

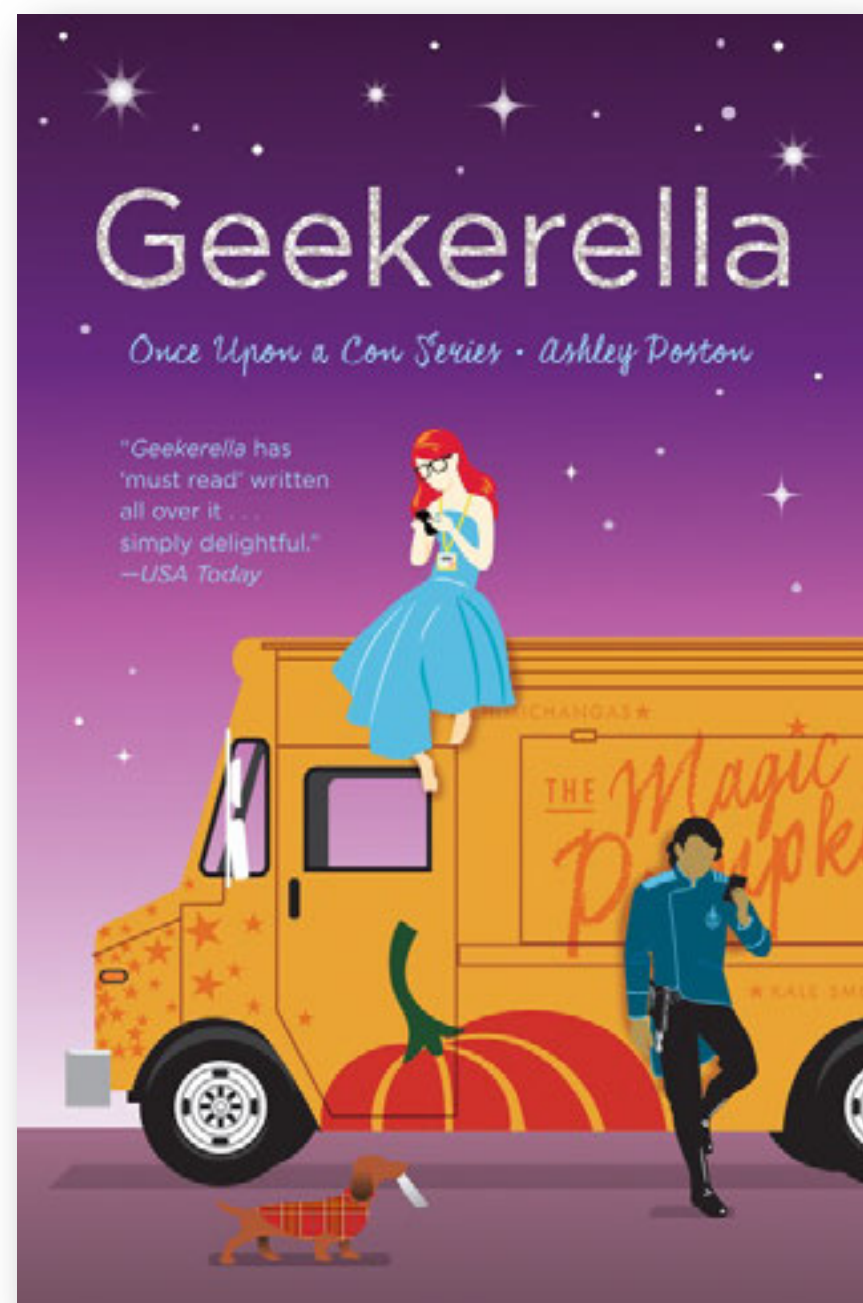



# PECULIAR CHILDREN



Discover why more than 10 million readers have visited the world of the Peculiar Children!

Translated into over 40 languages!

Published by Quirk Books in 2011, *Miss Peregrine's Home for Peculiar Children* follows sixteen-year-old Jacob Portman as he journeys from a sleepy Florida suburb to a remote island off the coast of Wales. There he stumbles upon the ruins of Miss Peregrine's orphanage and discovers the shocking fate of the children who lived there long ago—and may live there still.

*Miss Peregrine* was followed by two best-selling sequels, *Hollow City* and *Library of Souls*. All three novels are illustrated with dozens of vintage found photographs.

**Active Rights Sold:** Albanian, Armenian, Azerbaijani, Bahasa Indonesia, Bulgarian, Catalan, Chinese (Simp & Trad), Croatian, Czech, Danish, Dutch, French, German, Hebrew, Italian, Japanese, Korean, Latvian, Lithuanian, Norwegian, Portuguese in Brazil ONLY, Romanian, Russian, Serbian, Sinhalese, Slovak, Spanish, Swedish, Turkish, Ukrainian

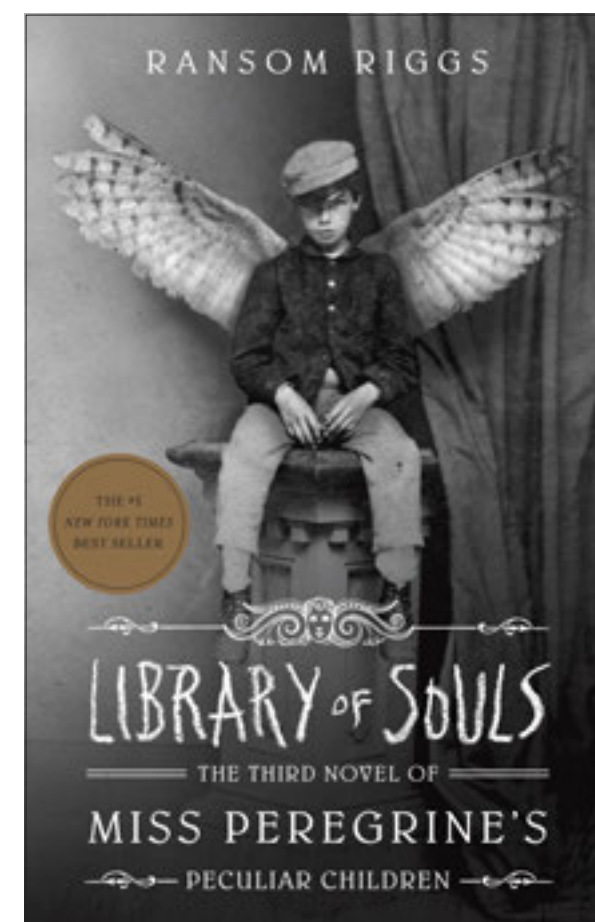
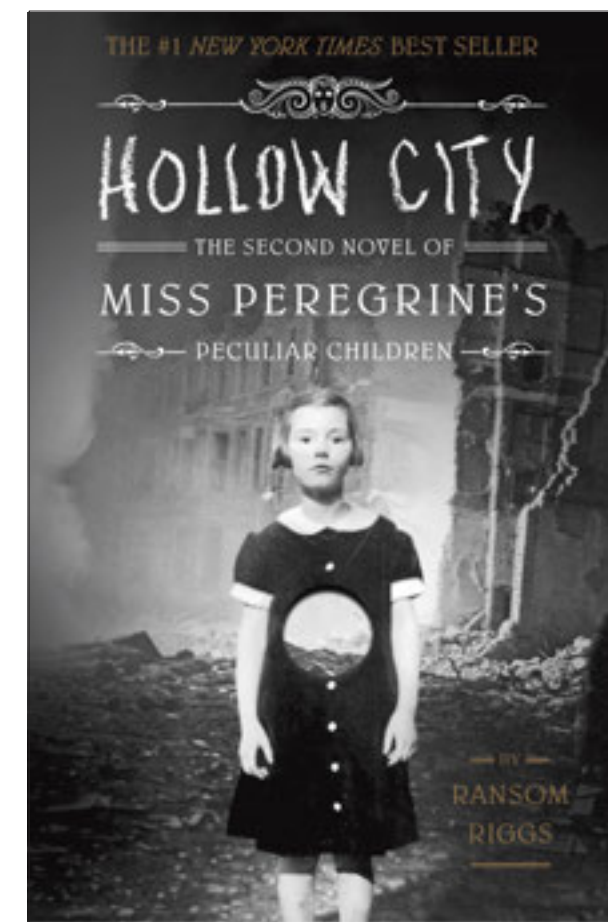
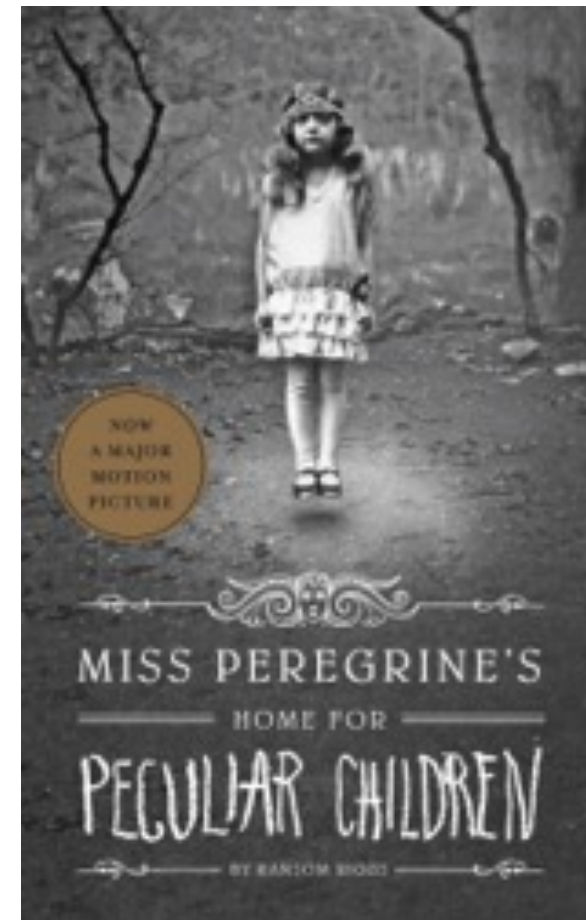

**YOUNG  
ADULT**

NONFICTION

# GIRLS RESIST!

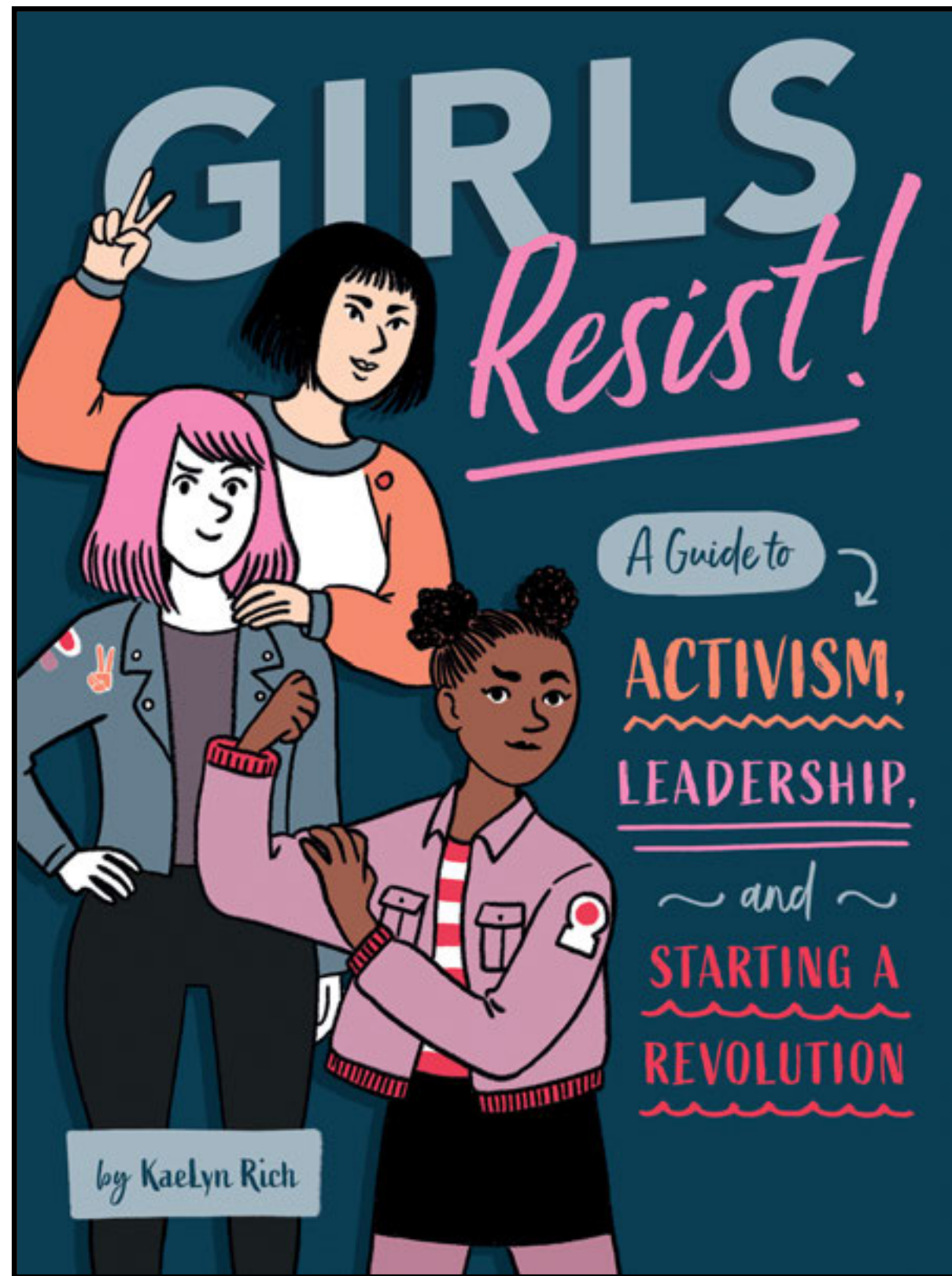

## Girls Resist!

By KaeLyn Rich, ill. Giulia Sagramola

October 2019, for age 14+

An activism handbook for teen girls ready to fight for change, social justice, and equality.

Take on the world and make some serious change with this handbook on everything activism, social justice, and resistance. With in-depth guides to everything from picking a cause, planning a protest, and raising money to running smooth meetings, promoting awareness on social media, and being an effective ally, *Girls Resist!* Will show you how to go from "mad as heck about the way the world is going" to "effective leader who gets stuff done."

Veteran feminist organizer KaeLyn Rich shares tons of expertise that will inspire you as it teaches you. Grab this handbook to crush inequality!

**Rights sold:** Indonesian, Hungarian, Korean, Japanese, Polish, Portuguese

For more info: [rights@quirkbooks.com](mailto:rights@quirkbooks.com)

# FANGIRL'S GUIDE TO THE UNIVERSE



## The Fangirl's Guide to the Universe

By Sam Maggs

October 2020, for age 13+

From notable geek girl Sam Maggs, *The Fangirl's Guide to the Galaxy* is the ultimate handbook for teens living the nerdy life.

Fandom, pop culture, feminism, cosplay, cons, books, memes, podcasts, vlogs, OTPs and RPGs and MMs and more—there's never been a better time to be a fangirl, or a better guide to navigate the wide universe of fandoms.

Learn how to make nerdy friends, how to rock cosplay, how to write fanfic with feels, how to defeat internet trolls, how to attend your first con, and more!

*The Fangirl's Guide to the Universe* highlights the joys of fandom community and offers a fun, feminist take on the often male-dominated world of geekdom.

For more info: [rights@quirkbooks.com](mailto:rights@quirkbooks.com)

All translation rights available.

# FANGIRL'S JOURNAL FOR LEVELING UP

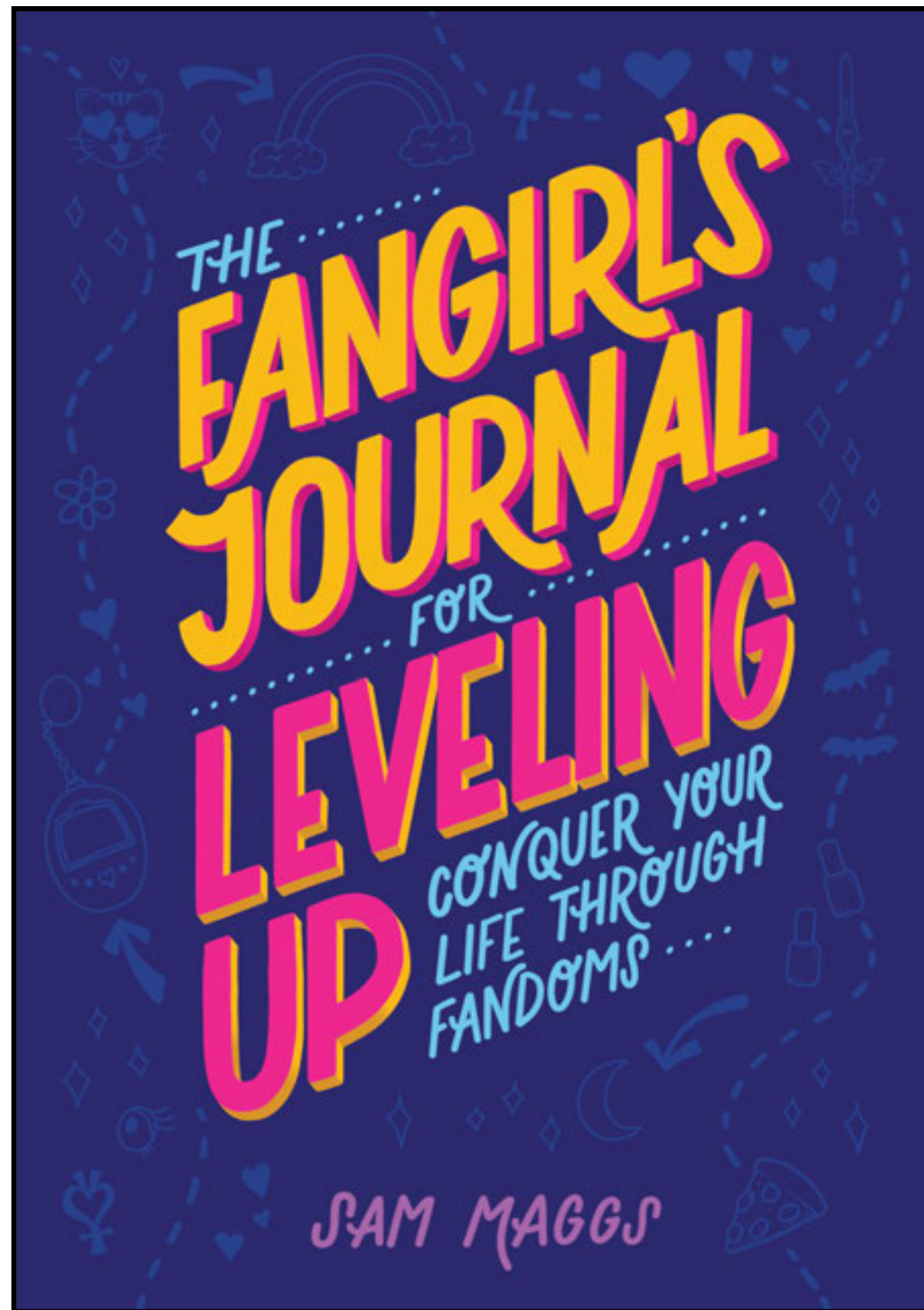

## The Fangirl's Journal for Leveling Up

By Sam Maggs

October 2020, for age 13+

A companion to *The Fangirl's Guide to the Universe*, this guided journal by Sam Maggs includes prompts, interviews, and illustrations to help you get in touch with your dreams, plans, and faves.

Fandom is an excellent way to discover who you really are. Your OTPs, NOTPS, and even OT3s actually say a lot about you, if you're willing to listen hard enough. With this journal, you can examine your current fandoms, explore new ones, and even push the boundaries of your own creativity. Start your very own transformative works with prompts for fanfic and fanart, fill checklists for what to watch or read next, learn definitions of fandom terms, and read wisdom from your favorite geeky gals.

All translation rights available.

For more info: [rights@quirkbooks.com](mailto:rights@quirkbooks.com)



**To register interest and request review materials:**

Contact your local subagent, or email [rights@quirkbooks.com](mailto:rights@quirkbooks.com).

Katherine McGuire

Assistant Director, Subsidiary Rights & Business Development

**Quirk Books**, 215 Church Street, Philadelphia PA 19106, USA

[Katherine@quirkbooks.com](mailto:Katherine@quirkbooks.com) +1 215-627-3581 x222



**QUIRK**

**B O O K S**